



Pioneer *sound.vision.soul*

DVD Recorder & VCR

DVR-RT501-S

DVR-RT401-S

DVR-RT301-S



Register Your Product at
www.pioneerelectronics.com (for U.S.)
www.pioneerelectronics.ca (for Canada)

Operating Instructions

RW
COMPATIBLE





The lightning flash with arrowhead, within an equilateral triangle, is intended to alert the user to the presence of uninsulated "dangerous voltage" within the product's enclosure that may be of sufficient magnitude to constitute a risk of electric shock to persons.

CAUTION

**RISK OF ELECTRIC SHOCK
DO NOT OPEN**

CAUTION:
TO PREVENT THE RISK OF ELECTRIC SHOCK, DO NOT REMOVE COVER (OR BACK). NO USER-SERVICEABLE PARTS INSIDE. REFER SERVICING TO QUALIFIED SERVICE PERSONNEL.



The exclamation point within an equilateral triangle is intended to alert the user to the presence of important operating and maintenance (servicing) instructions in the literature accompanying the appliance.

D1-4-2-3_En

IMPORTANT NOTICE – THE SERIAL NUMBER FOR THIS EQUIPMENT IS LOCATED IN THE REAR. PLEASE WRITE THIS SERIAL NUMBER ON YOUR ENCLOSED WARRANTY CARD AND KEEP IN A SECURE AREA. THIS IS FOR YOUR SECURITY.

D1-4-2-6-1_En

Information to User

Alteration or modifications carried out without appropriate authorization may invalidate the user's right to operate the equipment.

D8-10-2_En

NOTE: This equipment has been tested and found to comply with the limits for a Class B digital device, pursuant to Part 15 of the FCC Rules. These limits are designed to provide reasonable protection against harmful interference in a residential installation. This equipment generates, uses and can radiate radio frequency energy and, if not installed and used in accordance with the instructions, may cause harmful interference to radio communications. However, there is no guarantee that interference will not occur in a particular installation. If this equipment does cause harmful interference to radio or television reception, which can be determined by turning the equipment off and on, the user is encouraged to try to correct the interference by one or more of the following measures:

- Reorient or relocate the receiving antenna.
- Increase the separation between the equipment and receiver.
- Connect the equipment into an outlet on a circuit different from that to which the receiver is connected.
- Consult the dealer or an experienced radio/TV technician for help.

D8-10-1-2_En

CAUTION : USE OF CONTROLS OR ADJUSTMENTS OR PERFORMANCE OF PROCEDURES OTHER THAN THOSE SPECIFIED HEREIN MAY RESULT IN HAZARDOUS RADIATION EXPOSURE.

CAUTION : THE USE OF OPTICAL INSTRUMENTS WITH THIS PRODUCT WILL INCREASE EYE HAZARD. D6-8-2-1_En

WARNING – TO PREVENT FIRE OR SHOCK HAZARD, DO NOT EXPOSE THIS APPLIANCE TO RAIN OR MOISTURE.

D1-4-2-1_En

CAUTION: This product satisfies FCC regulations when shielded cables and connectors are used to connect the unit to other equipment. To prevent electromagnetic interference with electric appliances such as radios and televisions, use shielded cables and connectors for connections.

D8-10-3a_En

This Class B digital apparatus complies with Canadian ICES-003.

Cet appareil numérique de la Classe B est conforme à la norme NMB-003 du Canada.

D8-10-1-3_EF





IMPORTANT SAFETY INSTRUCTIONS

READ INSTRUCTIONS — All the safety and operating instructions should be read before the product is operated.

RETAIN INSTRUCTIONS — The safety and operating instructions should be retained for future reference.

HEED WARNINGS — All warnings on the product and in the operating instructions should be adhered to.

FOLLOW INSTRUCTIONS — All operating and use instructions should be followed.

CLEANING — The product should be cleaned only with a polishing cloth or a soft dry cloth. Never clean with furniture wax, benzene, insecticides or other volatile liquids since they may corrode the cabinet.

ATTACHMENTS — Do not use attachments not recommended by the product manufacturer as they may cause hazards.

WATER AND MOISTURE — Do not use this product near water — for example, near a bathtub, wash bowl, kitchen sink, or laundry tub; in a wet basement; or near a swimming pool; and the like.

ACCESSORIES — Do not place this product on an unstable cart, stand, tripod, bracket, or table. The product may fall, causing serious injury to a child or adult, and serious damage to the product. Use only with a cart, stand, tripod, bracket, or table recommended by the manufacturer, or sold with the product. Any mounting of the product should follow the manufacturer's instructions, and should use a mounting accessory recommended by the manufacturer.

CART — A product and cart combination should be moved with care. Quick stops, excessive force, and uneven surfaces may cause the product and cart combination to overturn.



VENTILATION — Slots and openings in the cabinet are provided for ventilation and to ensure reliable operation of the product and to protect it from overheating, and these openings must not be blocked or covered. The openings should never be blocked by placing the product on a bed, sofa, rug, or other similar surface. This product should not be placed in a built-in installation such as a bookcase or rack unless proper ventilation is provided or the manufacturer's instructions have been adhered to.

POWER SOURCES — This product should be operated only from the type of power source indicated on the marking label. If you are not sure of the type of power supply to your home, consult your product dealer or local power company.

LOCATION — The appliance should be installed in a stable location.

NONUSE PERIODS — The power cord of the appliance should be unplugged from the outlet when left un-used for a long period of time.

GROUNDING OR POLARIZATION

- If this product is equipped with a polarized alternating current line plug (a plug having one blade wider than the other), it will fit into the outlet only one way. This is a safety feature. If you are unable to insert the plug fully into the outlet, try reversing the plug. If the plug should still fail to fit, contact your electrician to replace your obsolete outlet. Do not defeat the safety purpose of the polarized plug.
- If this product is equipped with a three-wire grounding type plug, a plug having a third (grounding) pin, it will only fit into a grounding type power outlet. This is a safety feature. If you are unable to insert the plug into the outlet, contact your electrician to replace your obsolete outlet. Do not defeat the safety purpose of the grounding type plug.

POWER-CORD PROTECTION — Power-supply cords should be routed so that they are not likely to be walked on or pinched by items placed upon or against them, paying particular attention to cords at plugs, convenience receptacles, and the point where they exit from the product.

OUTDOOR ANTENNA GROUNDING — If an outside antenna or cable system is connected to the product, be sure the antenna or cable system is grounded so as to provide some protection against voltage surges and built-up static charges. Article 810 of the National Electrical Code, ANSI/NFPA 70, provides information with regard to proper grounding of the mast and supporting structure, grounding of the lead-in wire to an antenna discharge unit, size of grounding conductors, location of antenna-discharge unit, connection to grounding electrodes, and requirements for the grounding electrode. See Figure A.

LIGHTNING — For added protection for this product during a lightning storm, or when it is left unattended and unused for long periods of time, unplug it from the wall outlet and disconnect the antenna or cable system. This will prevent damage to the product due to lightning and power-line surges.

POWER LINES — An outside antenna system should not be located in the vicinity of overhead power lines or other electric light or power circuits, or where it can fall into such power lines or circuits. When installing an outside antenna system, extreme care should be taken to keep from touching such power lines or circuits as contact with them might be fatal.

OVERLOADING — Do not overload wall outlets, extension cords, or integral convenience receptacles as this can result in a risk of fire or electric shock.

OBJECT AND LIQUID ENTRY — Never push objects of any kind into this product through openings as they may touch dangerous voltage points or short-out parts that could result in a fire or electric shock. Never spill liquid of any kind on the product.

SERVICING — Do not attempt to service this product yourself as opening or removing covers may expose you to dangerous voltage or other hazards. Refer all servicing to qualified service personnel.

DAMAGE REQUIRING SERVICE — Unplug this product from the wall outlet and refer servicing to qualified service personnel under the following conditions:

- When the power-supply cord or plug is damaged.
- If liquid has been spilled, or objects have fallen into the product.
- If the product has been exposed to rain or water.
- If the product does not operate normally by following the operating instructions. Adjust only those controls that are covered by the operating instructions as an improper adjustment of other controls may result in damage and will often require extensive work by a qualified technician to restore the product to its normal operation.
- If the product has been dropped or damaged in any way.
- When the product exhibits a distinct change in performance — this indicates a need for service.

REPLACEMENT PARTS — When replacement parts are required, be sure the service technician has used replacement parts specified by the manufacturer or have the same characteristics as the original part. Unauthorized substitutions may result in fire, electric shock, or other hazards.

SAFETY CHECK — Upon completion of any service or repairs to this product, ask the service technician to perform safety checks to determine that the product is in proper operating condition.

WALL OR CEILING MOUNTING — The product should not be mounted to a wall or ceiling.

HEAT — The product should be situated away from heat sources such as radiators, heat registers, stoves, or other products (including amplifiers) that produce heat.

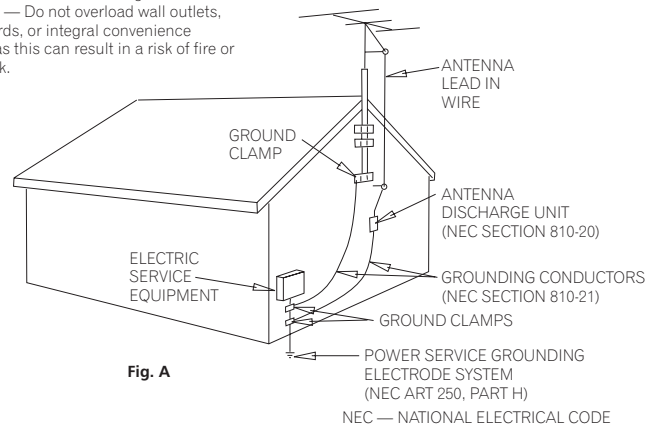

Fig. A

D1-4-2-2_En

**DANGER**

VISIBLE AND INVISIBLE LASER RADIATION WHEN OPEN. AVOID DIRECT EXPOSURE TO BEAM.

This product incorporates copyright protection technology that is protected by method claims of certain U.S. patents and other intellectual property rights owned by Macrovision Corporation and other rights owners. Use of this copyright protection technology must be authorized by Macrovision Corporation, and is intended for home and other limited viewing uses only unless otherwise authorized by Macrovision Corporation. Reverse engineering or disassembly is prohibited.

CAUTION

– PREVENT ELECTRIC SHOCK DO NOT USE THIS (POLARIZED) PLUG WITH AN EXTENSION CORD, RECEPTACLE OR OTHER OUTLET UNLESS THE BLADES CAN BE FULLY INSERTED TO PREVENT BLADE EXPOSURE.

ATTENTION

– POUR PREVENIR LES CHOCS ELECTRIQUES NE PAS UTILISER CETTE FICHE POLARISEE AVEC UN PROLONGATEUR UNE PRISE DE COURANT OU UNE AUTRE SORTIE DE COURANT, SAUF SI LES LAMES PEUVENT ETRE INSEREES A FOND SANS EN LAISSER AUCUNE PARTIE A DECOUVRETT.

D2-4-4-1_EF

NOTE TO CATV SYSTEM INSTALLER

THIS REMINDER IS PROVIDED TO CALL THE CATV SYSTEM INSTALLER'S ATTENTION TO ARTICLE 820-40 OF THE NEC THAT PROVIDES GUIDELINES FOR PROPER GROUNDING AND, IN PARTICULAR, SPECIFIES THAT THE CABLE GROUND SHALL BE CONNECTED TO THE GROUNDING SYSTEM OF THE BUILDING, AS CLOSE TO THE POINT OF CABLE ENTRY AS PRACTICAL.

D1-4-2-8_En

Recording equipment and copyright: You may use this product only to reproduce or copy materials for which you own the copyright or have obtained permission to copy from the copyright owner or for which you otherwise have a legal right to reproduce or copy. Unless you own the copyright or have obtained permission from the copyright owner or otherwise have a legal right to reproduce or copy, you may be violating the law, including copyright law, and may be subject to payment of damages and other remedies.

K018US_En

POWER-CORD CAUTION

Handle the power cord by the plug. Do not pull out the plug by tugging the cord and never touch the power cord when your hands are wet as this could cause a short circuit or electric shock. Do not place the unit, a piece of furniture, etc., on the power cord, or pinch the cord. Never make a knot in the cord or tie it with other cords. The power cords should be routed such that they are not likely to be stepped on. A damaged power cord can cause a fire or give you an electrical shock. Check the power cord once in a while. When you find it damaged, ask your nearest PIONEER authorized service center or your dealer for a replacement. **S002_En**

This product is for general household purposes. Any failure due to use for other than household purposes (such as long-term use for business purposes in a restaurant or use in a car or ship) and which requires repair will be charged for even during the warranty period. **K041_En**

WARNING: Handling the cord on this product or cords associated with accessories sold with the product will expose you to lead, a chemical known to the State of California and other governmental entities to cause cancer and birth defects or other reproductive harm.

Wash hands after handling

D36-P4_En

This product contains mercury. Disposal of this material may be regulated due to environmental considerations. For disposal or recycling information, please contact your local authorities or the Electronics Industries Alliance : www.eiae.org. **K057_En**

MOISTURE CONDENSATION

DO NOT OPERATE THIS DVD/VCR FOR AT LEAST TWO OR THREE HOURS WHEN MOISTURE IN THE AIR CONDENSES ON THE DVD/VCR.

WHAT IS MOISTURE CONDENSATION?

When cold liquid is poured into a glass, for example, water vapour in the air will condense on the surface of the glass. This is called moisture condensation.

MOISTURE WILL CONDENSE ON THE UNIT IN THE FOLLOWING CASES;

- When you move this DVD/VCR from a cold to a warm place.
- After heating a cold room or under extremely humid conditions.

WHEN YOU EXPERIENCE THE ABOVE CONDITIONS;

Plug the power cord into an AC outlet, set the STANDBY/ON switch to ON and leave the unit at room temperature until moisture condensation disappears. Depending on the surrounding conditions, this may take from two or three hours.



Dear Customer:

Selecting fine audio equipment such as the unit you've just purchased is only the start of your musical enjoyment. Now it's time to consider how you can maximize the fun and excitement your equipment offers. This manufacturer and the Electronic Industries Association's Consumer Electronics Group want you to get the most out of your equipment by playing it at a safe level. One that lets the sound come through loud and clear without annoying blaring or distortion and, most importantly, without affecting your sensitive hearing.

Sound can be deceiving. Over time your hearing "comfort level" adapts to higher volumes of sound. So what sounds "normal" can actually be loud and harmful to your hearing. Guard against this by setting your equipment at a safe level BEFORE your hearing adapts.

To establish a safe level:

- Start your volume control at a low setting.
- Slowly increase the sound until you can hear it comfortably and clearly, and without distortion.

Once you have established a comfortable sound level:

- Set the dial and leave it there.

Taking a minute to do this now will help to prevent hearing damage or loss in the future. After all, we want you listening for a lifetime.

We Want You Listening For A Lifetime

Used wisely, your new sound equipment will provide a lifetime of fun and enjoyment. Since hearing damage from loud noise is often undetectable until it is too late, this manufacturer and the Electronic Industries Association's Consumer Electronics Group recommend you avoid prolonged exposure to excessive noise. This list of sound levels is included for your protection.

Decibel Level Example

30	Quiet library, soft whispers
40	Living room, refrigerator, bedroom away from traffic
50	Light traffic, normal conversation, quiet office
60	Air conditioner at 20 feet, sewing machine
70	Vacuum cleaner, hair dryer, noisy restaurant
80	Average city traffic, garbage disposals, alarm clock at two feet.

THE FOLLOWING NOISES CAN BE DANGEROUS UNDER CONSTANT EXPOSURE

90	Subway, motorcycle, truck traffic, lawn mower
100	Garbage truck, chain saw, pneumatic drill
120	Rock band concert in front of speakers, thunderclap
140	Gunshot blast, jet plane
180	Rocket launching pad

Information courtesy of the Deafness Research Foundation.



S001_En

CAUTION:

This product is a class 1 laser product, but this product contains a laser diode higher than Class 1. To ensure continued safety, do not remove any covers or attempt to gain access to the inside of the product. Refer all servicing to qualified personnel.

CLASS 1 LASER PRODUCT
LASER KLASSE 1
クラス1レーザー製品

The following caution label appears on your unit.
Location: inside of the unit

CAUTION CLASS 3B VISIBLE AND INVISIBLE LASER RADIATION WHEN OPEN, AVOID EXPOSURE TO THE BEAM.

ATTENTION RADIATIONS LASER VISIBLES ET INVISIBLES DE CLASSE 3B QUAND OUVERT. ÉVITEZ TOUT EXPOSITION AU FAISCEAU.

ADVARSEL KLASSE 3B SYNLIG OG USYNLIG LASERSTRÅLING VED ÅBNING. UNDGÅ UDSÆTTELSE FOR STRÅLING.

WARNING KLASSE 3B SYNLIG OCH OSYNLIG LASERSTRÅLNING NÄR DENNA DEL ÄR ÖPPNAD. UNDVIK ATT UTSÄTTA DIG FÖR STRÅLEN.

VORSICHT BEI GEÖFFNETER ABDECKUNG IST SICHTBARE UND UNSICHTBARE LASERSTRÄHLUNG DER KLASSE 3B IM GERÄTEINNEREN VORHANDEN. AUGEN NICHT DEM LASERSTRAHLAUSSETZEN!

PRECAUCIACIÓN CUANDO SE ABRE HAY RADIACIÓN LÁSER DE CLASE 3B VISIBLE E INVISIBLE. EVITE LA EXPOSICIÓN A LOS RAYOS LÁSER.

VARO! AVATTAESSA OLET ALTTINA NÄKYVÄLLE JA NÄKYMÄTTÖMÄLLE LUOKAN 3B LASERSÄTEILYLLE. ÄLÄ KATSO SÄTEESEEN.

注意 ここを開くと CLASS 3B の可視レーザー光及び不可視レーザー光が出ます。ビームを直接見たり、触れたりしないこと。

DRW2247-A

D3-4-2-1-8_A_En



Contents

01 Before you start

Features	8
Discs which can be played back	9
Discs on which video can be recorded	10
Recording format	10
Disc playback in other players	11

02 Controls and displays

Front panel	12
Rear panel	12
Display window	13
Remote control	14
Putting the batteries in the remote control	15
Remote control basics	15
Using the remote control	15
Power Source	15

03 Connecting up

Antenna connection	16
Cable TV connections	18
Connections with the TV or audio component	20

04 Getting started

Auto clock setting / Setting the video channel	22
SETUP MENU	23
Using the SETUP MENU	23
Setting the language	24
OSD LANGUAGE	24
DVD MENU	24
AUDIO	24
SUBTITLE	24
Setting the parental control	25
Selecting parental control	25
Temporarily cancelling parental control	25
Setting the clock	26
CLOCK (manually)	26
AUTO CLOCK	26
STANDARD TIME (Time zone)	26
DAYLIGHT SAVING TIME	26
Setting the disc	27
REFORMAT	27
NEW DISC FORMAT	27
FINALIZE	28
PROTECT DISC	28

UNDO FINALIZE	28
DIMMER (Brightness of the display window)	29
DISPLAY (Turning the screen display "ON" or "OFF")	29
Setting the screen	29
TV SCREEN	29
STILL MODE	29
LINE1 INPUT / LINE2 INPUT	30
Setting the image quality	30
BRIGHTNESS	30
Setting the audio	30
DRC	30
EXTERNAL AUDIO INPUT	31
SAP (Second Audio Program)	31
Setting the recording	31
INITIAL REC TO	31
INITIAL REC MODE	31
AUTO CHAPTER	31
INDEX PICTURE	31
Setting the channel	32
TV/CABLE SELECT	32
AUTO CH MEMORY	32
ADD/DELETE (channels)	32
Setting other items	32
JPEG INTERVAL	32

05 Playback

Playback procedure	33
Playback by selecting a title	34
Checking media information	35
Special playback	36
Fast forward playback	36
Review playback	36
Still playback	36
Frame advance	36
Slow motion playback	36
Locating a chapter or track	36
Commercial skip / Locating a specific scene	37
Repeat playback	38
One touch repeat	38
A-B repeat playback	38
Title, Chapter repeat playback	38
Title selection / DVD menu	39
Changing angles / Zooming	40
Changing soundtrack language	41
Changing the subtitle language	41
The CD Track Info screen	42

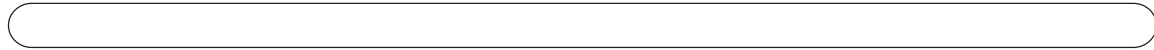







Playing back a selected track	42	Erasing a scene (Edit title)	66
Random playback	43	Combining the title	68
Repeat playback of selected track	43	Erasing a playlist	69
Repeat playback of all tracks	43	Editing an original title	70
Playing back programs	43	Adding a chapter mark	70
Playing back track by specifying the time	43	Combining chapters	72
MP3/WMA*/JPEG playback	44	Changing an original title name	72
Using the BROWSER screen	44	Erasing a scene (Edit title)	73
When the file to be displayed is selected	44	Erasing an original title	74
Playing back MP3/WMA files	45	Changing a disc name	75
Playing back JPEG files	46	Using the keyboard screen	76
Progressive scan	47		
Different scanning modes	47	08 Dubbing	
Loading and unloading a cassette tape	48	Dubbing a tape onto a disc	78
Loading	48	Dubbing a disc onto a tape	79
Unloading	48	Dubbing only the specified titles or the playlist	79
Cassette tape playback	49	Dubbing using other equipment	80
Forward/Reverse picture search mode	49	When a video is recorded using this unit	80
Special playback	50		
Picture search	50	09 Additional information	
Still picture	50	Language code list	81
Slow motion	50	Screen sizes and disc formats	81
Frame by frame picture	50	Glossary	82
Adjusting tracking condition	50	Error/Warning message list	84
Repeat playback	50	Troubleshooting	86
Commercial skip	50	Handling discs	88
To display VCR operation status	50	Storing discs	88
ZERO RETURN function / Video index search system	51	Damaged discs	88
		Cleaning the pickup lens	88
06 Recording		Handling video tapes	88
Read this before recording on disc	52	Storing video tapes	88
Recording a TV program	54	Video head cleaning	89
One-touch Timer Recording (OTR)	56	Moving the recorder	89
VCR Plus+® programming system	57	Resetting the recorder	89
Timer recording	59	Hints on installation	89
Stereo recording and playback	62	Specifications	90
07 Editing			
Editing the disc	63		
Editing a playlist	64		
Creating a playlist	64		
Changing a title name	65		

* WMA (Windows Media™ Audio) compatibility
Microsoft, Windows Media, and the Windows logo are trademarks, or registered trademarks of Microsoft Corporation in the United States and/or other countries.

Media mark

Each applicable media are indicated using the symbol shown below.

 : DVD-Video	 : DVD-R
 : DVD-RW in VR mode	 : Audio CD and CD-R/CD-RW
 : DVD-RW in Video mode	 : Video tape





Chapter 1

Before you start

Features

Not only can you playback and record video tapes, but you can also playback DVD discs or make recordings using DVD-RW, DVD-R discs with this unit. In addition, you can enjoy editing the programs you record.

Playback function

- **A realistic, powerful, Movie Theater sound** **DVD-Video**

When connected to Dolby Digital and DTS compliant devices, you can enjoy realistic, powerful surround sound.

- **Playback the scene you want to see immediately**

DVD-Video VR mode Video mode DVD-R

As DVD's do not require rewinding like video tapes, you can get to the scene you wish to watch immediately. A variety of search functions allow you to find the scene you wish to watch.

- **Title menu** **VR mode Video mode DVD-R**

As thumbnail images are displayed in the title menu, you can find the title you want to play back quickly.

- The title list appears on finalized DVD-RW disc (recorded in the Video mode) and DVD-R disc.

- **MP3/WMA/JPEG playback** **CD**

MP3 and WMA files can be played back. Also, you can display JPEG files on the TV screen and enjoy them as a slide show.



Note

- WMA and JPEG files can only be played back with RT501.

- **Progressive scan**

DVD-Video VR mode Video mode DVD-R

This unit supports the progressive scanning system. If your TV is equipped with component video input jacks which support the progressive video input, you can enjoy high quality picture. Check your TV/monitor for compatibility with this feature.

Recording function

- **Timer recording** **VR mode Video mode DVD-R VCR**

You can program the recorder to record up to 12 programs, up to a month in advance, using the VCR Plus+® system*1 for easy programming if you want. As well as single programs, you can specify daily or weekly recordings, too.

**1 VCR Plus+ and PlusCode are registered trademarks of Gemstar Development Corporation.*

The VCR Plus+ system is manufactured under license from Gemstar Development Corporation.

- **One-touch Timer Recording (OTR)**

VR mode Video mode DVD-R VCR

The One-touch Timer Recording feature provides a simple and convenient way to make a timed recording.

Edit function

- **Editing recorded material without changing the original titles** **VR mode**

You can create a playlist based on the original titles. The playlist won't affect the original titles. If you erase the playlist, the original titles remain. It is recommended to create and edit the playlist to prevent important titles from being erased accidentally.

- **Chapter mark** **VR mode**

You can add (or delete) a chapter mark to (from) the original title. This function is useful when searching for the scene you wish to watch that you have marked with the Chapter mark function.

- **Erasing scenes** **VR mode**

You can erase an unnecessary scene from the created playlist or the original titles.

- **Combining titles** **VR mode**

You can combine several original titles or playlists to a separate playlist.

Dubbing function

- **Dubbing a tape onto a disc or a disc onto a tape**

VR mode Video mode DVD-R VCR

With just this one unit, you can dub however you like, from video tape to disc, or from disc to video tape.

- Dubbing cannot be carried out when attempting to copy a "copy guarded" video tape or disc.



Before you start

01

Discs which can be played back

In this unit, use only discs that meet the standard, such as those bearing the below logo marks on the disc label surface. If you use a non-standard disc, we cannot guarantee playback. Even if such a disc can be played back, we cannot guarantee the image or sound quality. The DVD logo is a registered trademark.

Media type	Logo mark
DVD-Video	
DVD-RW Ver.1.0 Ver.1.1 Ver.1.2 Ver.1.1 CPRM support	
DVD-R Ver.2.0 (Ver.2.0/4x/8x)	
Audio CD*	
CD-R/CD-RW	

* This unit is designed to playback music Compact Discs (CD) that conform to the CD standard. CDs that contain (copy-restriction) signals to protect copyrights cannot be played back.

- **DVD** is a trademark of DVD Format/Logo Licensing Corporation.
- Playability of 'DualDisc'
 - The DVD-Audio content on DVD side of a DualDisc cannot be played with this product.
 - The DVD-Video content on DVD side of a DualDisc may or may not be played with this product.
 - Since audio content on 'non-DVD' side of a DualDisc is not compliant with the Compact Disc Digital Audio specification, it may or may not be played with this product.
 - If you need further information about playability of DualDisc, please see 'Service & Support' on the Pioneer web site (www.pioneerelectronics.com)

Older models of DVD recorders and DVD writers may reject DVD-RW Ver. 1.2 / 4x discs. If you want to share DVD-RW discs between this recorder and an older recorder/writer, we recommend using Ver. 1.1 discs.

The following table shows older Pioneer DVD recorder compatibility with DVD-RW Ver. 1.2 / 4x discs.

Model	Playable	Recordable
DVR-7000	Yes ^{1,2,3}	No
DVR-810H/DVR-57H DVR-210/DVR-310/DVR-510H	Yes ¹	No

¹ Discs should be finalized in this recorder before playing. Unfinalized VR mode and Video mode discs may not play.

² Cannot read the CPRM information will show in the display when you load a disc. However, this will not affect playback.

³ Copy-once protected disc titles will not play.

Region management information

This unit is designed and manufactured to support the region management information that is recorded on a DVD disc. If the region number written on the DVD disc does not correspond to the region number of this unit, this unit cannot play that disc.

- The region number of this unit is "1".
- The unit will play DVD-Video discs marked with labels containing "1" or "ALL".

Example:

Operating DVD-Video

- Some operations of DVD-Video may be prohibited by the manufacturer, or some operation methods or functions of the DVD-Video may be different from the description in this manual.
- If you attempt an operation that is prohibited by either the disc or the unit, a "⏸" mark will appear on the TV monitor. For operations prohibited by the disc, see the information that came with the disc.
- When the menu screen or the operation guide appears during disc playback, follow the displayed information.

Discs which cannot be played back

The discs listed below cannot be played back in general. Even if one of these can be played back, it may not be played back correctly. If a disc is played back by mistake, extensively loud sounds may blow the speakers or may damage the hearing of those in hearing range. Do not playback the discs listed below.

CDG, Photo-CD, CD-ROM, CD-TEXT, CD-EXTRA, VCD, SVCD, SACD, PD, CDV, DVD-ROM, DVD-RAM, DVD+R/RW, DVD audio, etc.

The below DVD-Video may not be played back.

- DVD-Video that do not have the region number "1" or "ALL".
- PAL or SECAM DVD-Video.
- Prohibited or business-use DVD-Video.

CD-R/CD-RWs cannot be played back for the following reasons.

- Compatibility of the disc and this unit.
- Compatibility of the disc and the recorder used.
- Unfinalized discs.

Do not playback the following discs. Playback of these discs may cause a failure.

- Discs on which paper, labels or stickers are affixed.
- Discs that have sticky areas left by adhesive tape.
- Special-shaped discs.

PC-created disc compatibility

Discs recorded using a personal computer may not be playable in this unit due to the setting of the application software used to create the disc. In these particular instances, check with the software publisher for more detailed information.



9

En



Discs on which video can be recorded

To record video with this unit, use the discs below:

Media type	Logo mark
DVD-RW Ver.1.0 Ver.1.1 Ver.1.2 Ver.1.1CPRM support	
DVD-R Ver.2.0 (Ver.2.0 /4x /8x)	

DVD-RW

- The disc can be erased and used again about 1,000 times.
- Only the VR mode can be used for Ver.1.0 discs.
- With Ver.1.1/1.2 discs, you can record by selecting the VR mode or Video mode.
- When you record in the VR mode, you can repeatedly record and erase. By erasing unnecessary titles, you effectively increase remaining time.
- When you record in the Video mode, you can record until the disc becomes full.
- When you use the Video mode, you can newly record on the disc by formatting the disc. However, if the disc is formatted, all the recorded contents will be erased.

DVD-R

- You can record on the disc only in the Video mode.
- You can record until the disc becomes full.
- Finalizing the discs allows playback on other DVD players. However, the finalized discs can no longer be recorded.
- Discs can be recorded to repeatedly until they are finalized.



Note

- There are some players that cannot playback discs that were recorded with this unit. We cannot guarantee the playback with other units.
- This unit cannot record on CD-R or CD-RW.
- This unit may not be able to record to or playback from discs that have been recorded on other units due to the recording conditions, surface dirt or scratches.
- Other units may not be able to record to or playback from discs that have been recorded on the unit due to the recording conditions, surface dirt or scratches.

Recording format

This unit has two modes for formatting discs for recording: VR mode and Video mode.

When a blank, new disc is loaded into this unit, the automatic format function starts to format the disc. (For the disc format setting in this step, see page 27.)

VR mode

- This mode can be used for DVD-RW.
- In this mode, the discs can be recorded and edited repeatedly.
- The disc recorded in this mode can be played back with other DVD-RW-compatible players.
- When a Ver.1.1 CPRM or Ver. 1.2 disc is used, you can record a "Copy Once" program (see page 53).

Video mode

- This mode can be used for DVD-R and DVD-RW (Ver.1.1/1.2).
- When you finalize the disc after recording, the disc recorded with this unit can be played back with other DVD players.
- Recording, editing or playback of an unfinalized disc can be done only with this unit. However, there is some limitation to editing operations.
- In this mode, you cannot record a "Copy Once" program (see page 53).
- When you record a TV program of a bilingual broadcast, only one of the audio modes can be recorded. You have to select it.

Format modes that can be used each disc

The usable format depends on the media type as shown in the below table.

Media type	Format	Available functions
DVD-RW Ver.1.0	VR mode	Playback, recording and editing (Original/playlist)
DVD-RW Ver.1.1 and 1.2	VR mode	Playback, recording and editing (Original/playlist)
	Video mode	Playback and recording Editing (with limitation)
DVD-R Ver.2.0 (Ver.2.0/4x/8x)	Video mode	Playback and recording Editing (with limitation)



Title/Chapter/Track

A DVD-Video has large partitions called "Titles", and smaller partitions within them called "Chapters". A music CD has other partitions called "Tracks". A number is allotted to each partition and these numbers are called "title numbers", "chapter numbers" or "track numbers".

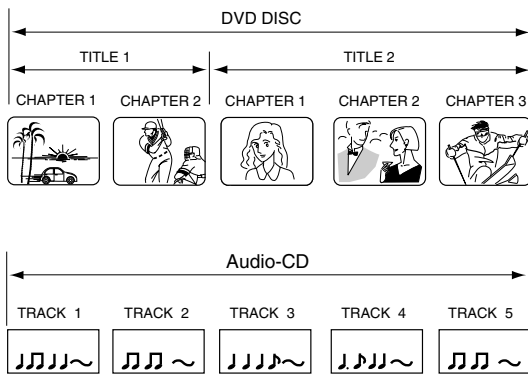

When recording in the VR mode

One-time recording is set to 1 title (1 chapter). However, if you stop recording temporarily or erase scenes by editing, the chapter will automatically be partitioned. The interval between chapters can be specified. (See page 31.)

When recording in the Video mode

One-time recording is set to 1 title. In recording, chapters are set automatically. The interval between chapters can be specified. (See page 31.)

Note

- The title, chapter and track are numbered, but some discs may not record the numbers.
- Recording on DVD-R/RW in the Video mode is a new standard approved at the 2000 DVD forum. Conformity to this standard varies with each DVD player manufacturer. Some models of DVD player or DVD-ROM drive, therefore, will not playback recorded videos.

Disc playback in other players

A disc recorded in this unit can be finalized. The disc can be played back in other players that can playback DVD-RW and DVD-R.

For more information on finalization, see "FINALIZE" in "Setting the disc" (page 28).

When recording in the VR mode

Even if a disc recorded in the VR mode is finalized, you can record or edit by cancelling the finalization. (See "UNDO FINALIZE" on page 28.)

When you playback the disc with another player, make sure that the DVD player supports DVD-RW and bears the following mark.



When recording in the Video mode

When a disc recorded in the Video mode is finalized, it cannot be recorded onto any more. Therefore, before finalization, be sure to perform all desired recording. After finalization, a title list that can be used by the DVD player is automatically created.

Note

- The finalization process may require from a few minutes up to 1 hour depending on the disc type and the amount of free space on the disc.
- A DVD-RW Ver.1.1/1.2 recorded in the Video mode cannot be recorded or edited after finalization, but if you format the disc by erasing all the content, you can again record on this disc.
- A finalized disc may not play because of the condition of the DVD or the compatibility with the player used for playback.
- Some players may not playback the discs recorded with this unit. We cannot guarantee the playback using other players.



Chapter 2 Controls and displays

Front panel

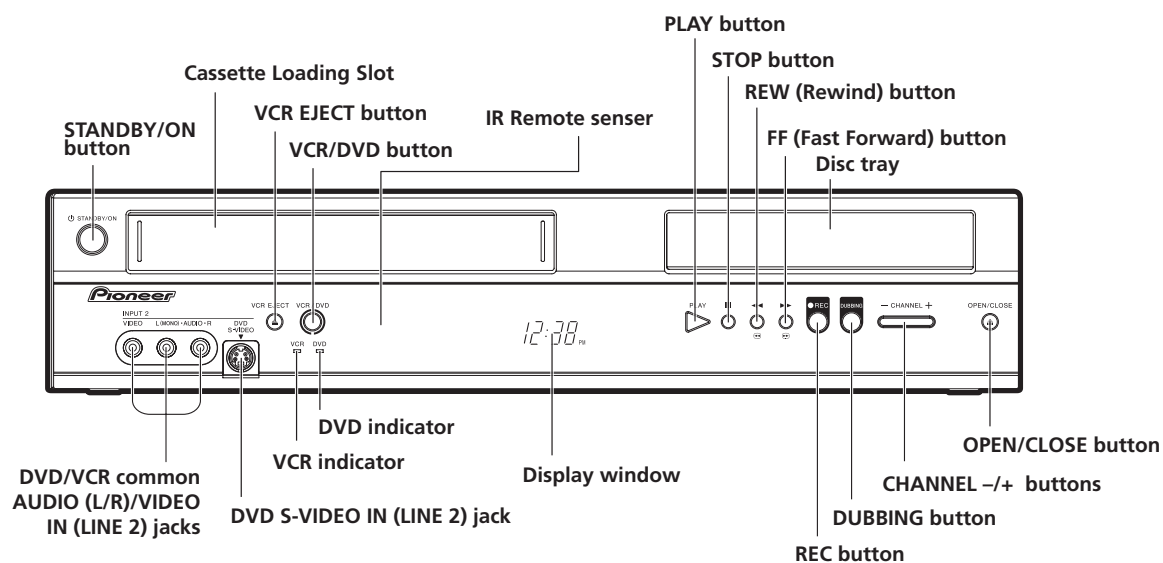

Rear panel

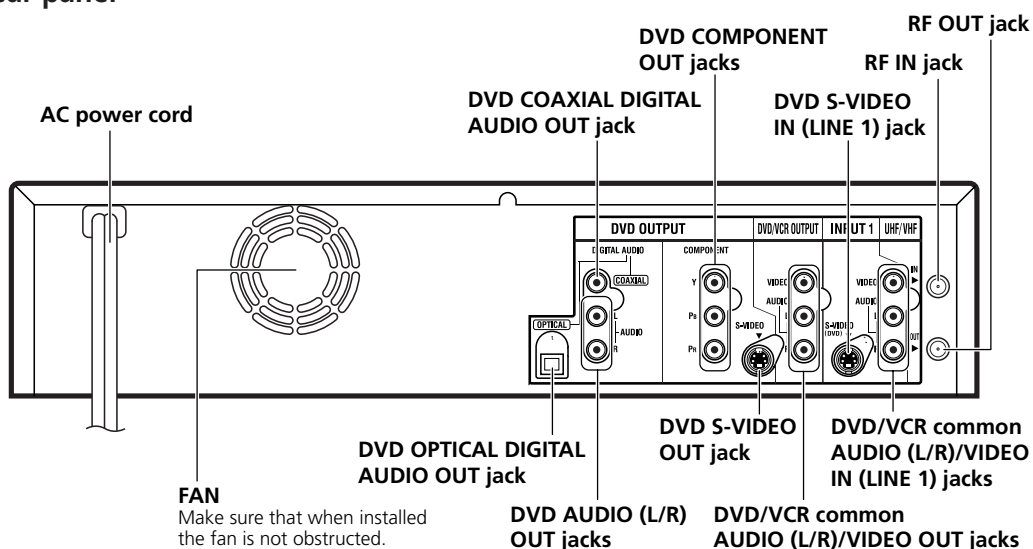



Controls and displays

02

Display window

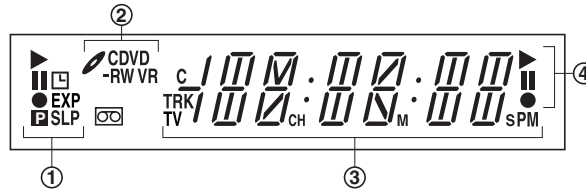

No.	Display	Description
①		Lights during video tape playback.
		Video tape is temporarily stopped.
		Lights during video tape recording.
		Progressive scanning mode.
		Timer recording display.
	XP/SP/LP/EP	4 DVD recording modes. XP, SP, LP or EP is selected in turn by pressing the REC MODE/SPEED repeatedly.
	SP/EP	2 VCR recording modes. SP or EP is selected in turn by pressing the REC MODE/SPEED repeatedly.
②		Appears when a CD is inserted.
		Appears when a CD-R is inserted.
		Appears when a CD-RW is inserted.
		Appears when a DVD-Video is inserted.
		Appears when a DVD-R is inserted.
		Appears when a DVD-RW is inserted.
	VR	Appears when a DVD-RW in VR mode is inserted. When the disc is set to video mode, VR does not appear.
		Video tape is in the unit.
③	10:00	Clock display (Colon [:] flashes).
	01H00M00S	Counter display in hour/minute/second for VCR/DVD, minute/second for CD.
	C 36CH	Cable TV channel display.
	2CH	TV channel display.
	TRK 002	Track number display for CD.
	TV	Appears when the tuner built into this unit is not selected. When you press TV/VIDEO, TV disappears.
	PM	Display for afternoon (out in the morning).
	L1/L2	The external input channel (L1 or L2) display.
	Err	Error display.
④		Lights during playback of DVD and CD. Flashes in auto resume.
		DVD or CD is temporarily stopped.
		Lights during DVD recording.

Note

- Some discs may not playback correctly, or chapter number, playback time, etc may not be displayed.

13

En



Remote control

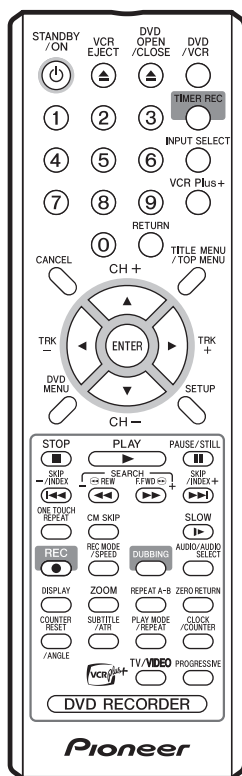

- 1 STANDBY/ON** (page 22)
Turns power on/off.
- 2 VCR EJECT** (page 48)
Ejects the cassette tapes.
- 3 DVD OPEN/CLOSE** (page 33)
Opens or closes the tray.
- 4 DVD/VCR** (page 78, 79)
Switches to operation between VCR and DVD.
- 5 0-9**
Use for direct TV channel selection of TV (page 54); setting the input (page 37, 76); entering a password (page 25); entering a Pluscode for VCR Plus+ timer programming (page 58).
- 6 TIMER REC** (page 59, 61)
Sets the unit to start recording at a preset time.
- 7 INPUT SELECT** (page 80)
Switches between the external inputs.

- 8 VCR Plus+** (page 58)
Display the VCR Plus+ program screen.
- 9 RETURN** (page 23, 45)
Closes the menu window.
- 10 CANCEL**
Cancels input data in the setting mode (page 25); deletes the timer recording program (page 59, 61).
- 11 TITLE MENU/TOP MENU** (page 34, 39, 42, 64)
Selects titles of a DVD disc.
- 12 CH +/-** (page 54)
Use to select TV channels.
▲ / ▼ (page 23, 33, 37, 60)
Up/down cursor buttons
- 13 TRK +/-** (page 50)
Use to adjust the VCR manual playback tracking.
◀ / ▶ (page 33, 37, 60)
Left/right cursor buttons
- 14 ENTER** (page 23, 33, 37, 58, 60)
Use to select menu options.
- 15 DVD MENU** (page 39)
Displays the menu of the DVD disc.
- 16 SETUP** (page 23, 58, 60)
Displays the setup menu.
- 17 STOP** (page 33, 49, 55)
Stops playback or recording.
- 18 PLAY** (page 33, 49)
Starts playback.
- 19 PAUSE/STILL** (page 36, 50)
Pauses recording or playback (press again to restart).
- 20 SKIP** ◀◀ / ▶▶ (page 36)
Skips forward or back chapters.
- 21 INDEX** -◀◀ / ▶▶ (page 51)
Searches for INDEX marks on a tape
- 22 REW/SEARCH -** (page 36, 49, 50)
Rewind/review playback
- 23 F.FWD/SEARCH +** (page 36, 49, 50)
Fast forward/forward search playback
- 24 ONE TOUCH REPEAT** (page 38)
Repeats playback of the last 10 seconds of video.
- 25 CM SKIP** (page 37, 50)
Skips commercial breaks.

- 26 SLOW** (page 36, 50)
Starts slow motion playback.
- 27 REC** (page 54, 56, 80)
Starts recording.
- 28 REC MODE/SPEED** (page 54, 56)
Selects the recording mode.
- 29 DUBBING** (page 78)
Copies VCR to DVD or DVD to VCR.
- 30 AUDIO/AUDIO SELECT**
Switches sound between mono and stereo (page 62); changes the language of the DVD (page 41).
- 31 DISPLAY** (page 35, 51)
Displays VCR or DVD operation status.
- 32 ZOOM** (page 40)
- 33 REPEAT A-B** (page 38)
Repeats playback between A and B.
- 34 ZERO RETURN** (page 51)
Stops the tape when the counter reaches 00_H00_M00_S.
- 35 COUNTER RESET** (page 51)
Resets the counter to 00_H00_M00_S.
- 36 ANGLE** (page 40)
Changes the DVD playback angle.
- 37 SUBTITLE** (page 41)
Selects subtitles of the DVD disc.
- 38 ATR** (page 50)
Digital auto tracking for VCR playback.
- 39 PLAY MODE** (page 37)
Selects the playback mode.
- 40 REPEAT** (page 38, 50)
Selects the repeat playback mode.
- 41 CLOCK/COUNTER** (page 51)
Changes the front panel display mode.
- 42 TV/VIDEO** (page 22, 55)
Switches input between the TV and VIDEO.
- 43 PROGRESSIVE** (page 47)
Activates the progressive scanning mode.



Putting the batteries in the remote control

1 Open the battery compartment cover on the back of the remote control.

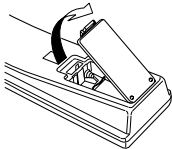

2 Insert two AAA/R03 batteries into the battery compartment following the indications (+,-) inside the compartment.

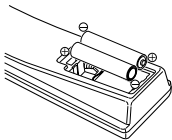

3 Close the cover.

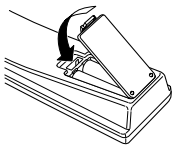

Note

Incorrect use of batteries can result in hazards such as leakage and bursting. Please observe the following:

- Don't mix new and old batteries together.
- Don't use different kinds of battery together—although they may look similar, different batteries may have different voltages.
- Make sure that the plus and minus ends of each battery match the indications in the battery compartment.
- Remove batteries from equipment that isn't going to be used for a month or more.
- Do not try to recharge batteries not intended to be recharged; they can overheat and rupture. (Follow battery manufacturer's directions.)
- When disposing of used batteries, please comply with governmental regulations or environmental public instruction's rules that apply in your country or area.

Remote control basics

- Press **STANDBY/ON** to turn the DVD/VCR on or off.
- Press **CH +** or **CH -** to move through the channels one channel at a time.

- The **▲ / ▼ / ◀ / ▶** are also used to navigate on-screen menu system.
- You can directly access specific channels using **numeric keys**.
- Each press of **DVD/VCR**, switches the screen between the DVD screen (DVD mode) and the VCR screen (VCR mode).

Using the remote control

Keep in mind the following when using the remote control:

- Make sure that there are no obstacles between the remote and the remote sensor on the unit.
- Remote operation may become unreliable if strong sunlight or fluorescent light is shining on the unit's remote sensor.
- Remote controllers for different devices can interfere with each other. Avoid using remotes for other equipment located close to this unit.
- Replace the batteries when you notice a fall off in the operating range of the remote.
- Use within the operating range and angle, as shown.

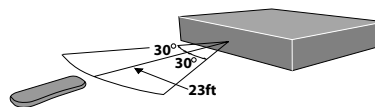

Power Source

TO USE AC POWER SOURCE

Use the AC polarized line cord provided for operation on AC. Insert the AC cord plug into a standard 120V 60Hz polarized AC outlet.

Note

- Never connect the AC line cord plug to other than the specified voltage (120V 60Hz). Use the attached power cord only.
- If the polarized AC cord does not fit into a non-polarized AC outlet, do not attempt to file or cut the blade. It is the user's responsibility to have an electrician replace the obsolete outlet.
- If you cause a static discharge when touching the unit and the unit fails to function, simply unplug the unit from the AC outlet and plug it back in. The unit should return to normal operation.

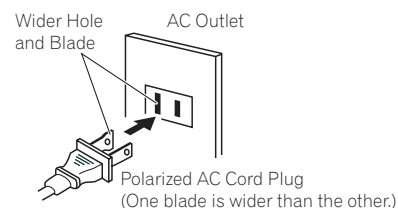



Chapter 3 Connecting up

Important

- Before making or changing any rear panel connections, make sure that all components are switched off and unplugged from the wall outlet.

Antenna connection

If you are using an antenna system, follow these instructions. If you are a Cable TV subscriber, skip ahead to page 18 for the proper connections.

ANTENNA TO DVD/VCR CONNECTION

The DVD/VCR must be connected “between” the antenna and the TV. First, disconnect the antenna from the TV and connect it to the DVD/VCR. Then connect the DVD/VCR to the TV. Below are 3 common methods of connecting an antenna system to a DVD/VCR. Find the type of antenna system you are using and follow the connection diagram.

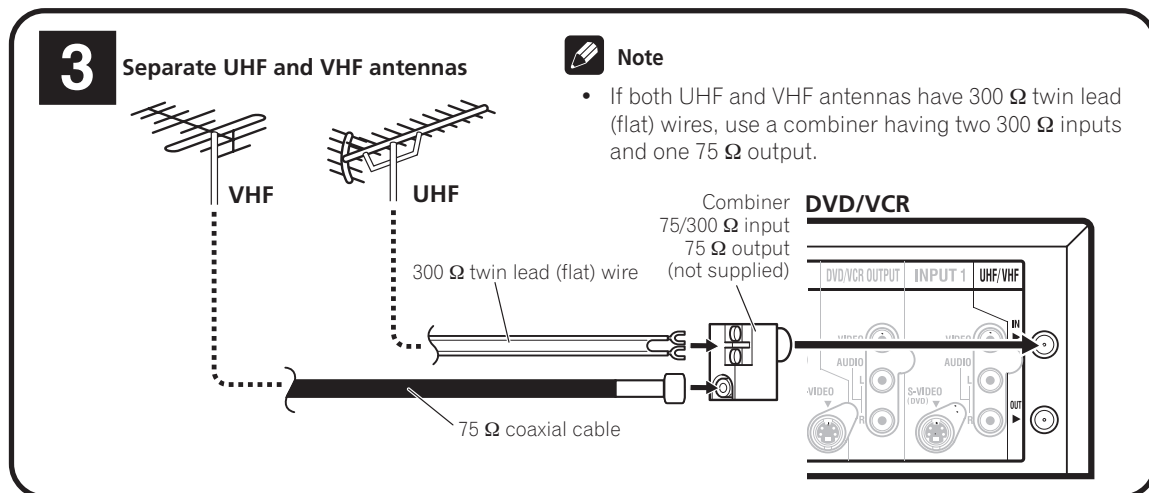
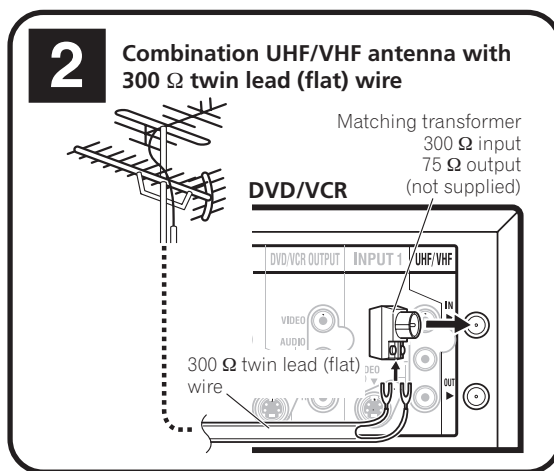
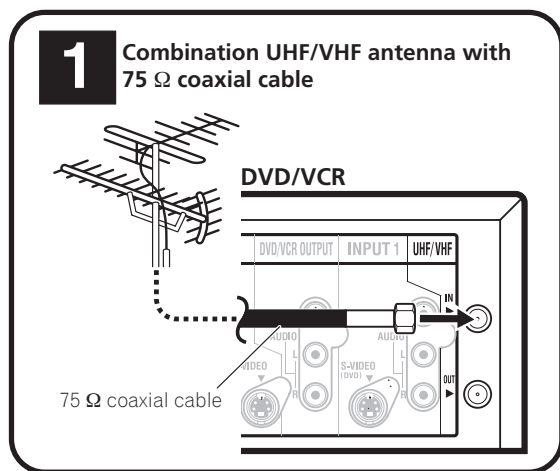



Connecting up

03

DVD/VCR TO TV CONNECTION

After you have connected the antenna to the DVD/VCR, you must connect the DVD/VCR to the TV. Below are 3 common methods of connecting your DVD/VCR to a TV. Find the type of TV you are using and follow the connection diagram.

This DVD/VCR has a single 75 Ω output for connection to a TV. If your TV has separate UHF and VHF antenna inputs (numbers 2 and 3 below), use a splitter to connect the DVD/VCR to the TV for UHF and VHF reception.

Note

- If a UHF or VHF antenna is used, set the TV/CABLE menu option to the "TV" mode.

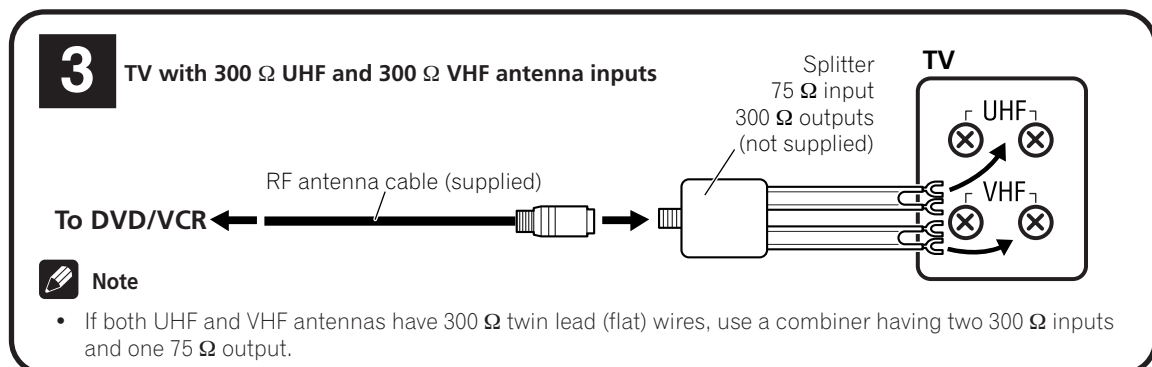
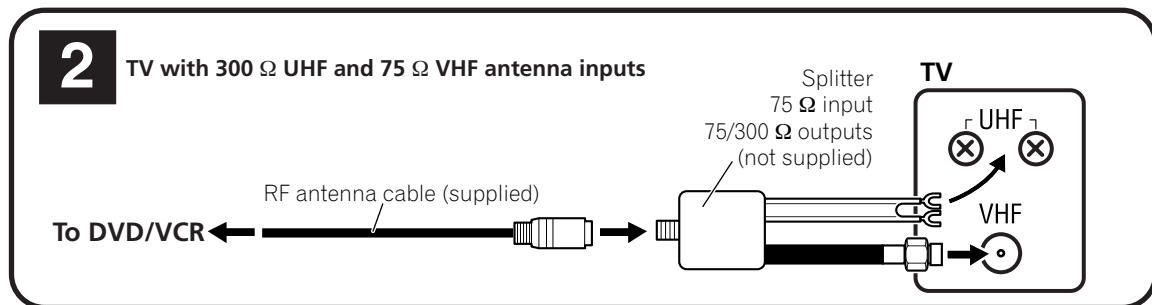
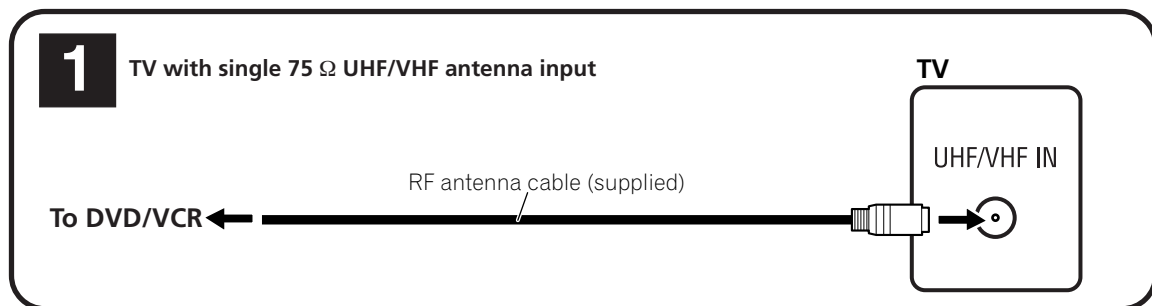

Note

- A clear picture will not be obtained by the DVD/VCR unless the antenna signal is good. Connect the antenna to the DVD/VCR properly.
- For better quality recording, an indoor antenna or a telescopic antenna is not recommended. The use of an outdoor type antenna is required.
- If you are not sure about the connection, please refer to qualified service personnel.

17

En





Cable TV connections

Many cable companies offer services permitting reception of extra channels including pay or subscription channels. This DVD/VCR has an extended tuning range and can be tuned to most cable channels without using a cable company supplied converter box, except for those channels which are intentionally scrambled. If you subscribe to a special channel which is scrambled, you must have a descrambler box for proper reception.

1 DVD/VCR

Incoming cable

TV
UHF/VHF IN (ANT)

Allows

- Recording of nonscrambled channels.
- Use of the programmable timer.
- Recording of one channel while watching another.

2 DVD/VCR

Incoming cable

Converter/descrambler

TV
UHF/VHF IN (ANT)

Note

- To record from converter/descrambler, DVD/VCR tuner must be tuned to the converter output channel, usually channel 3 or 4.

Allows

- Recording of channels through the converter box (scrambled and unscrambled).
- Using the programmable timer to record only the channel selected at the converter box.

Prevents

- Recording one channel while watching another.
- Using the DVD/VCR tuner to select channels.

3 DVD/VCR

Incoming cable

Converter/descrambler

TV
UHF/VHF IN (ANT)

Note

- If you are playing a tape or using the tuner built into the DVD/VCR, the converter must be set to the video channel output of the DVD/VCR (either 3 or 4).

Allows

- Recording of nonscrambled channels.
- Use of the programmable timer.
- Recording an unscrambled channel while watching any channel selected at the converter box.

Prevents

- Recording scrambled channels.

**Note**

- Whenever a converter/descrambler box is placed before the DVD/VCR, you must tune the DVD/VCR to the output of the converter/descrambler box, usually channel 3 or 4.





Connecting up

03

Important

- **Make sure the TV/CABLE menu option is set to the "CABLE" mode.**

This DVD/VCR cannot receive scrambled programs since it does not contain a descrambler. In order to receive scrambled programs, your existing descrambler must be used. Descrambler boxes are available from cable companies. Consult your local Cable TV company for more information concerning connection to their descrambler equipment. There are many ways to connect your DVD/VCR to a cable system. Below are six common methods of connection.

4

Allows

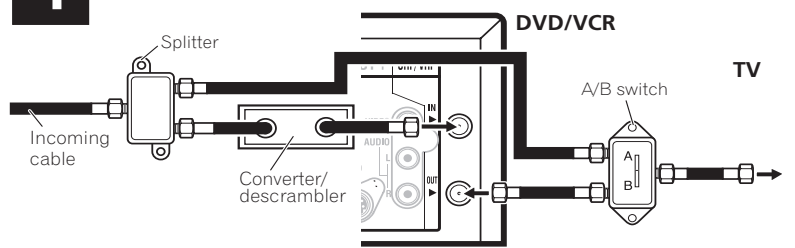

Prevents

TV

- Recording of one channel while watching another.
- Using the programmable timer to record only the channel selected at the converter box.
- Recording of all channels through the converter box.

- Watching scrambled channels while recording another channel.
- Using the DVD/VCR tuner to select channels.

5

Allows

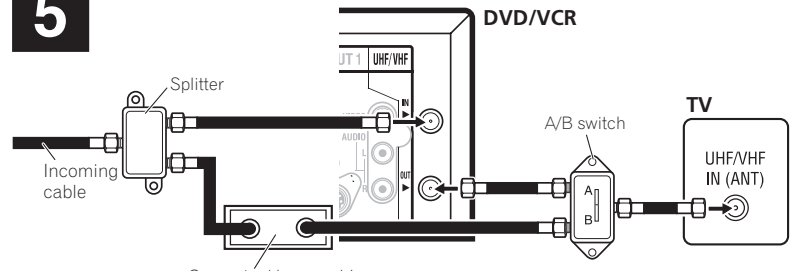

Prevents

TV

- Recording of nonscrambled channels.
- Recording of one channel while watching another.
- Watching premium channels through the converter while recording nonscrambled channels.
- Using the programmable timer.

- Recording scrambled channels.

6

Allows

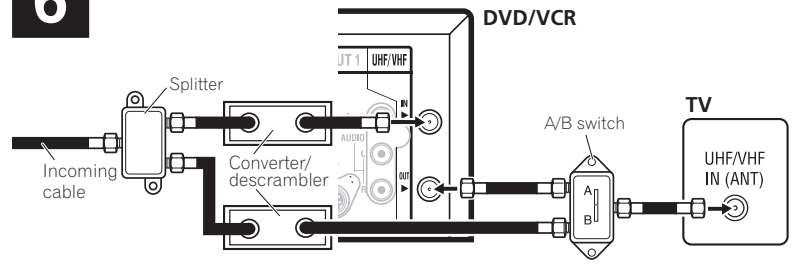

Prevents

TV

- Recording of all channels through the converter box.
- Recording a scrambled or unscrambled channel while watching another (scrambled or unscrambled) channel.
- Using the programmable timer to record only the channel selected at the converter box.

- Using the DVD/VCR tuner to select channels.

19

En





03 Connecting up

Connections with the TV or audio component

The exact arrangement you use to interconnect various video and audio components to the DVD/VCR is dependent on the model and features of each component. Check the Owner's Manual provided with each component for the location of video and audio inputs and outputs.

Connect to a TV with Audio/Video output

You can enjoy playback by connecting the unit to a TV. Connect the unit to a TV equipped with audio input (L/R) and video input jacks using the supplied audio/video cable.

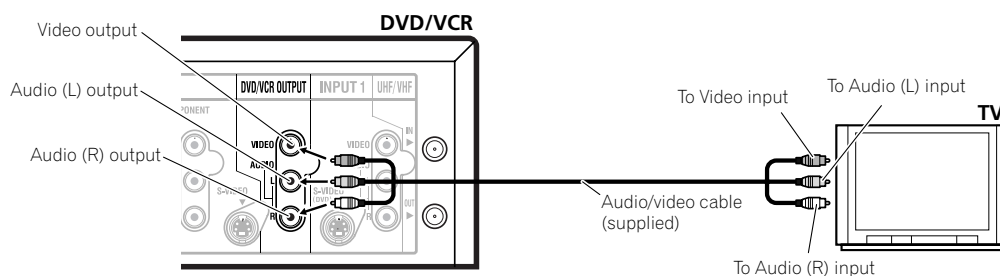

Connect to a TV with S-Video output (for DVD/CD playback)

If your TV has an S-Video input, you can get higher quality by connecting it with the S-Video output of the unit using an S-Video cable (not supplied) instead of connecting the video input of the TV to the video output jack of the unit.

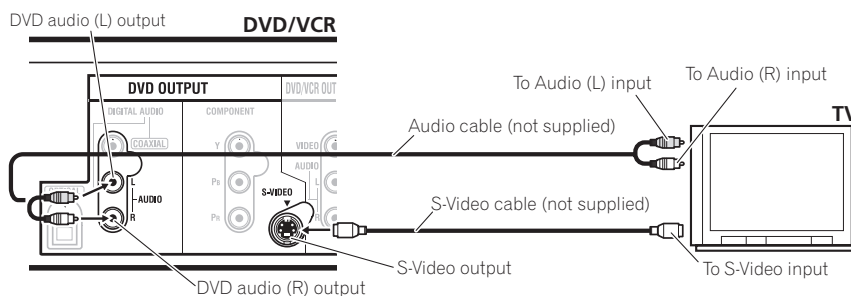

Connect to a TV with Component video output (for DVD/CD playback)

You can enjoy the highest quality picture by connecting the unit's component video out jacks to the component video input jacks of your TV, with component video cables (not supplied).

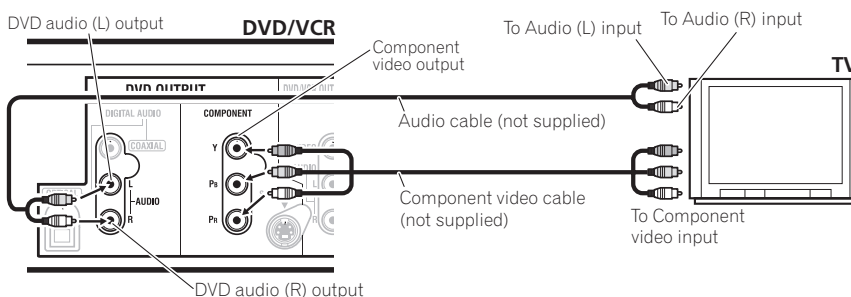

Note

- When connecting to a TV using the video or S-Video jack, make sure that the progressive indicator on the display window is not lit. If it is lit, the video and S-Video outputs do not feed the correct signals and you cannot see any picture. To turn off the progressive indicator, make the progressive scanning mode inactive (see page 47).
- If the component video input jacks on a TV are the BNC type, use an adapter to convert the RCA jacks from the component video cables to BNC (not supplied).





Connecting up

03

Connect to a stereo amplifier with audio output

You can enjoy high quality audio by connecting the audio output to your amplifier. Connect the audio output jacks to any line-level inputs (such as AUX, DVD, CD, etc.) of an audio amplifier.

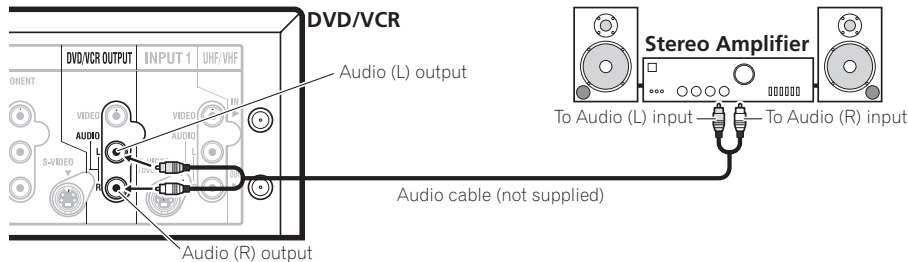

Connect to an AV Amplifier with built-in digital surround (for DVD/CD playback)

If you are using an Amplifier with a built-in digital surround as follows, you can enjoy the various audio systems such as Dolby Digital and DTS by using the optical or coaxial digital output.

Use this connection to connect an:

- AV amplifier with built-in *Dolby Digital decoder
- AV amplifier with built-in *DTS decoder

Note

- You may connect to a TV with a component video cable (not supplied) or S-Video cable (not supplied) instead of a video cable (not supplied).

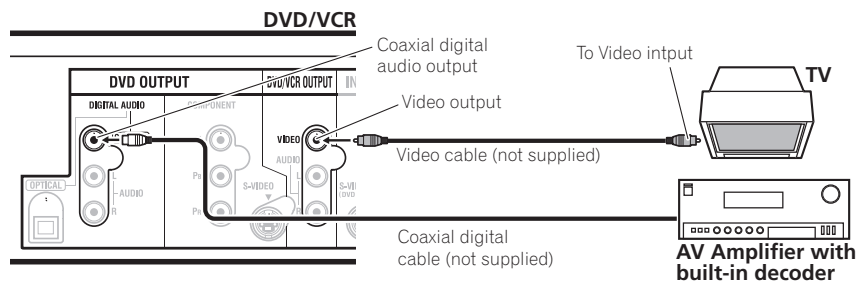

Connecting the optical digital cable (for DVD/CD playback)

You may connect to an AV Amplifier with an optical digital cable (not supplied) instead of a coaxial digital cable.

When you connect the optical digital cable (not supplied), remove the dust protection cap from the rear panel. When not using the optical digital cable, attach the dust protection cap to protect against dust.

Note

- The DVD OUTPUT jacks (OPTICAL, COAXIAL, AUDIO L/R, S-VIDEO and COMPONENT) are useful only for DVD section. The VHS signal is output only from the composite jacks (DVD/VCR OUTPUT) and UHF/VHF OUT.
- When you make the connections above, do not set DOLBY DIGITAL to DOLBY DIGITAL or DTS to ON on the AV amplifier. If you do, a loud noise will suddenly come out from the speakers, affecting your ears or causing the speakers to be damaged.
- Caution for the optical digital audio output connector: Do not connect to an amplifier (with an optical digital input connector) which does not contain a Dolby Digital or DTS decoder. Otherwise, any attempt to play DVDs may cause such a high level of noise that it may be harmful to your ears and damage your speakers.
- If you use an optical or a coaxial connection, when you play a DVD-RW (VR mode) which was recorded from a bilingual broadcast, you can only hear the audio mode that was selected when it was recorded. See page 10.
- DTS audio will be output only from the COAXIAL or OPTICAL output. To hear DTS audio, DTS-Decoder is necessary.
- When playing DTS-encoded CDs, only noise will be heard from the speakers or analogue stereo outputs.
- Some DTS decoders which do not support DVD-DTS interface may not work properly with the unit.

21

En



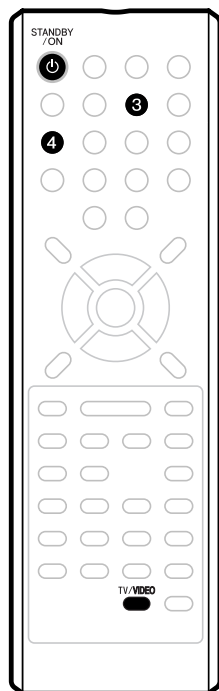

Chapter 4 Getting started

**Note**

- **If the unit does not operate properly, or there is no key operation from the unit and/or the remote control:** Static electricity, etc., may affect the operation. Disconnect the AC power cord once, then connect it again.

Auto clock setting

Preparation:

You must connect the antenna or cable before connecting the AC cord to the power source.

Wait 30 minutes with the power turned off, after the antenna or cable is connected, for the auto clock feature to activate.

After the clock is set automatically, you may have to set the time zone and daylight saving time. (See page 26.)

Press **STANDBY/ON** to turn on the DVD/VCR after the auto clock operation completed.

- When shipped from the factory, the "AUTO CLOCK" option is set to "ON" position.
- If you turn the DVD/VCR on during auto clock setting, the clock is not set.
- After a power failure or disconnection of the power plug, the clock setting will be lost. In this case, wait 30 minutes before turning the DVD/VCR on.
- With cable box connection, if the auto clock setting is unsuccessful, select the PBS channel carrying the XDS information, then turn the DVD/VCR off. After 30 minutes, turn the DVD/VCR on.
- If the clock is not set automatically, set the clock manually. (See page 26.)

Setting the video channel

To view playback of a recorded tape or DVD disc, or to watch a program selected by the VCR's channel selector, the TV must be set to channel 3 or 4 (video channel).

When a TV is connected with the 75 Ω coaxial cable only:

- 1 Press and hold 3 or 4 on the remote control for 3 seconds in the standby mode to select CH 3 or 4. The selected channel number will flash on the display for about 4 seconds.**
- 2 Turn ON the TV and set to CH 3 or 4 to correspond with the channel selected in step 1.**
- 3 Press STANDBY/ON to turn on the DVD/VCR.**
- 4 Press TV/VIDEO to select the VIDEO position.** The TV indicator will appear in the display.



Getting started

04

5 Select any channel to receive a TV station in your area.

The channel number will appear on the screen for about 4 seconds.

For a push-button TV tuner

If CH 3 or 4 corresponding to the video channel cannot be tuned on your TV, proceed as follows: set the VCR 3/4 channel selector and the TV to CH 3 or 4, playback a prerecorded tape and tune the TV to receive a sharp color picture from the video cassette recorder. Refer to your TV owner's manual for details.



Note

- When shipped from factory, the video channel is set to CH 3.

SETUP MENU

The SETUP MENU consists of several menus where you can make various settings concerning language, audio functions, and images. In addition, this menu includes a clock, channel and other things that require setting just after purchase.

For details of each menu, see the corresponding section in this chapter.

Using the SETUP MENU

The following example shows the basic setting procedure of the SETUP MENU. The remote control keys that operate the SETUP MENU are displayed at the bottom of the screen.

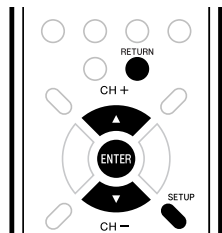

Note

- For items that require different operations from the basic setting procedure, the setting procedure is described in each individual section.
- The item which is indicated by green color cannot be selected.

1 Press SETUP while the DVD and video tape is stopped.

The SETUP MENU screen will appear.

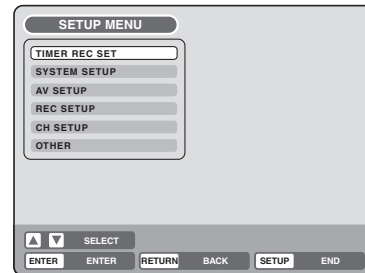

2 Press ▲ or ▼ to select the desired menu and press ENTER.

The submenu screen of the selected menu will appear.

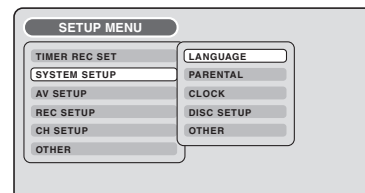

3 Press ▲ or ▼ to select the desired submenu and press ENTER.

The screen for the selected submenu will appear.

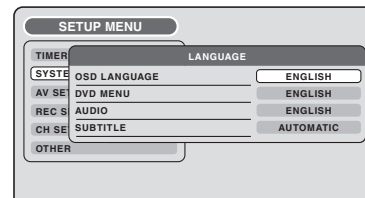

4 Press ▲ or ▼ to select the desired item you want, and press ENTER.

Selectable items will be listed.

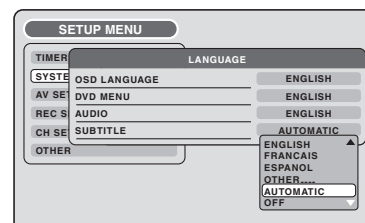

5 Press ▲ or ▼ to select the desired item and press ENTER.

This completes the setting procedure.

- To return to the previous screen, press RETURN.
- To close the SETUP MENU, press SETUP.

23

En





Setting the language

You can choose the language of the menu screen, DVD menu, DVD audio and subtitles.

Preparation:

- Turn ON the TV and set it to the video input mode.
- Select "**LANGUAGE**" from "**SYSTEM SETUP**". For the procedure, see steps 1 to 3 in "Using the SETUP MENU" on page 23.

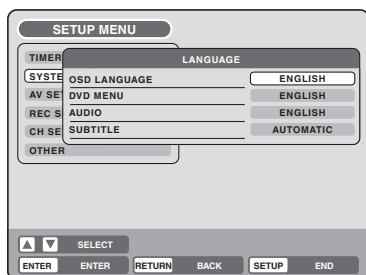

OSD LANGUAGE

You can set the language for on screen display. Select "OSD LANGUAGE" and select the language from the list below.

Selectable languages:

ENGLISH, FRANCAIS, ESPANOL

DVD MENU

When several menu languages are recorded on a DVD, you can select the language to be used for the DVD menu.

Select "DVD MENU" and select the language from the list below.

Selectable languages:

ENGLISH, FRANCAIS, ESPANOL

The selected language is the firstpriority menu language.

OTHER

If you want to select another language, before pressing **ENTER**, input the language code by using the **numeric keys**. (See the Language code list on page 81). Then press **ENTER**.

- If you input a wrong number, press **CANCEL**.

AUDIO

When several audio languages are recorded on a DVD, you can select the audio language to be played back. The selected language remains in effect after the power is turned off or the disc is replaced.

Select "AUDIO" and select the audio language from the list below.

Selectable languages:

ENGLISH, FRANCAIS, ESPANOL

The language you have selected will play if it is recorded on the disc.

ORIGINAL

The unit will select the first priority language of each disc.

OTHER

If you want to select another language, before pressing **ENTER**, input the language code by using the **numeric keys**. (See the Language code list on page 81). Then press **ENTER**.

- If you input a wrong number, press **CANCEL**.



Note

- If the selected language is not recorded on the disc, the firstpriority language is selected.

SUBTITLE

When several subtitles languages are recorded on DVD, you can select the language to be used for the subtitles. The selected language remains in effect after the power is turned off or the disc is replaced.

Select "SUBTITLE" and select the menu language from the list below.

Selectable languages:

ENGLISH, FRANCAIS, ESPANOL

The subtitle is displayed with the selected language if it is recorded on the disc.

OTHER

If you want to select another language, before pressing **ENTER**, input the language code by using the **numeric keys**. (See the Language code list on page 81). Then press **ENTER**.

- If you input a wrong number, press **CANCEL**.

AUTOMATIC

- The unit will automatically select the same language in the AUDIO setting.
- When the unit selects the same language as the AUDIO setting, the subtitles will not appear during playback.
- When you do not use the same language as the AUDIO setting, the subtitles will appear during playback.

OFF

Subtitles do not appear.



Note

- If the selected language is not recorded on the disc, the firstpriority language is selected.



Setting the parental control

Some discs are specified as not suitable for children. This unit can prevent playback of such discs.

Preparation:

- Turn ON the TV and set it to the video input mode.
- Select "PARENTAL" from "SYSTEM SETUP". For the procedure, see steps 1 to 3 in "Using the SETUP MENU" on page 23.

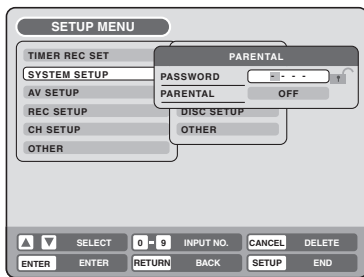

Selecting parental control

Select "PARENTAL" and select the parental control level. If the recorder is set to a lower level than the disc, it will require you to enter a password before the disc will play.

To lock the selected parental control level

- 1 To lock the selected parental control level, press ▲ or ▼ to select "PASSWORD".
- 2 Use the numeric keys to input a 4-digit password.
 - If you input a wrong number, press CANCEL.
 - Be sure to remember this number!
- 3 Press ENTER.



To cancel the locked parental control level

- 1 Select "PASSWORD" shown in step 1 of the above section and use the numeric keys to input the password.
- 2 Press ENTER.

The locked mark "🔒" will change to an unlocked mark "🔓".

Then, you can change the parental control level, or enter a new password.

Note

- The selected level will apply to operations executed after this.
- The unit cannot restrict playback of some discs.
- Some discs may not be encoded with specific rating level information though its disc jacket says "adult". Parental control will not work with those discs.
- If you forget the password, you can reset the recorder to its factory settings (see Resetting the recorder on page 89), then set a new password.

Temporarily cancelling parental control

Parental control can temporarily be cancelled with some DVDs.

- 1 Playback a DVD. (See page 33.)
- 2 If the DVD disc has been designed to temporarily cancel the rating level, the screen that follows the "READING" screen will change. If you select "YES" with the ENTER, the message "YOUR DISC EXCEEDS THE PARENTAL CONTROL LEVEL 1." (for example) will then appear.

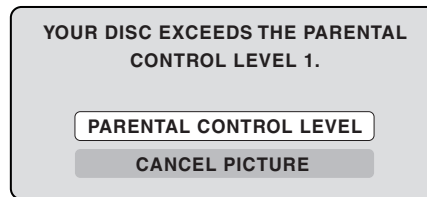

- 3 If you wish to cancel the set rating level temporarily, select "PARENTAL CONTROL LEVEL" with ▲ or ▼, then press ENTER. If the password has been selected, the password input screen will appear.

Alternatively, if the password has not been set, playback will commence. If you don't know (or have forgotten) the password, select "CANCEL PICTURE".

The setting screen will disappear. Press OPEN/CLOSE to remove the disc.

- 4 Use the numeric keys to input the password.
 - To interrupt the input process, press RETURN.
- 5 Press ENTER.
- 6 Playback will commence if the entered password was correct.

Note

- This temporary cancellation of the rating level will remain active until the disc is ejected. When the disc is ejected, the original rating level will be set again automatically.



Setting the clock

The clock is set to the correct time automatically, but it can also be set manually. The clock can be set for daylight saving time and time zone.

Preparation:

- Turn ON the TV and set it to the video input mode.
- Select “**CLOCK**” from “**SYSTEM SETUP**”. For the procedure, see steps **1** to **3** in “Using the SETUP MENU” on page 23.

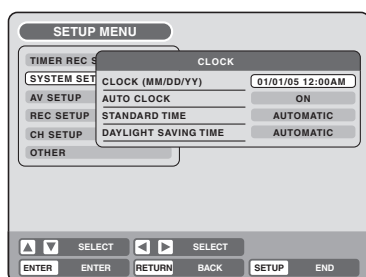

CLOCK (manually)

You can manually set the date, year and present time with the remote control.

Ex.: Setting the clock to “10:20AM” October, 30th, 2005.

1 Select “**CLOCK**” and press **ENTER**.

01/01/05 12:00AM

2 Select the desired items using **◀** or **▶** (month, date, year, hour, minute and AM/PM) then press **ENTER**.

3 Press **▲** or **▼** to set the value of the selected item.

- For the minutes, press **▲** or **▼** once to set the time minute by minute, or hold down either of buttons for several seconds to set the time in 10-minute intervals.

10/30/05 10:20AM

4 Repeat steps 2 and 3 to set the date, year and present time, and press **ENTER**. The **SETUP MENU** will close.

This completes clock time setting.

AUTO CLOCK

You can automatically set the clock by turning “ON” the AUTO CLOCK function.

When you want to set the auto clock function to “OFF”, select “AUTO CLOCK”, press **ENTER** and select “OFF” from the list.

For more information see page 22.



Note

- In case of a power failure, the clock will continue to operate for another 30 minutes with quartz-controlled precision. To indicate that the power failure has lasted for an excessive period of time “0:00” will appear on the display. In this case readjust time and date.

STANDARD TIME (Time zone)

In the rare event that you live within the broadcast range of two stations in two different time zones, the DVD/VCR may recognize the wrong station for the auto clock set. To correct the situation:

Select “STANDARD TIME” and select the time zone from the list below.

Selectable time zones and correction times

ATLANTIC:	GMT – 4 hours (GMT: Greenwich Mean Time)
EASTERN:	GMT – 5 hours
CENTRAL:	GMT – 6 hours
MOUNTAIN:	GMT – 7 hours
PACIFIC:	GMT – 8 hours
ALASKA:	GMT – 9 hours
HAWAII:	GMT – 10 hours
AUTOMATIC:	AUTO SET



Note

- When shipped from the factory, the “TIME ZONE” is set to “AUTOMATIC”.
- After making the auto clock setting, in some cases the clock may display another time zone. You can correct the clock by selecting your time zone setting above.
- When the clock is not set or you set the clock manually, the time zone setting is not available.

DAYLIGHT SAVING TIME

You can set the clock to daylight saving time automatically or manually.

To select daylight saving time, select “DAYLIGHT SAVING TIME” and select “ON”, while to cancel the daylight saving time, select “OFF”.

ON: For manual setting (forward 1 hour)

OFF: For manual setting (back 1 hour)

AUTOMATIC: For automatic setting (read XDS in the signal)



Note

- When you want to set daylight saving time, on the first Sunday in April you set it to “ON”, and on the last Sunday in October you set it to “OFF”.
- When shipped from the factory, the “DAYLIGHT SAVING TIME” option is set to “AUTOMATIC”.
- When the clock is not set, the daylight saving time setting is not available.
- When there is no daylight saving time in your area, always select “OFF”.



Setting the disc

You can format, protect, or finalize a disc.

Preparation:

- Turn ON the TV and set it to the video input mode.
- Select **"DISC SETUP"** from **"SYSTEM SETUP"**. For the procedure, see steps **1** to **3** in "Using the SETUP MENU" on page 23.

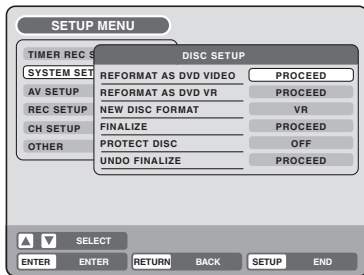

NEW DISC FORMAT

If you insert an unused disc, the disc is automatically formatted.

If you use the DVD-RW (Ver.1.1/1.2), you can select the mode to be used for automatic format. Select "NEW DISC FORMAT" and select the mode from the list below.

VR: Format the disc in the VR mode.

VIDEO: Format the disc in the Video mode.

When you insert an unused disc, the following message screen will appear.

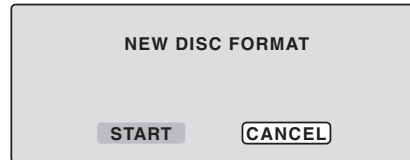

- When you select "START" and press **ENTER**, formatting will start. The screen below will appear.

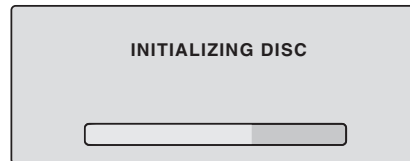

- When you select "CANCEL" and press **ENTER**, the normal TV screen will appear.

Note

- If a recorded disc has scratches or contamination on it, the "NEW DISC FORMAT" screen may appear. If this happens, select "CANCEL".

REFORMAT

You can format a recorded DVD-RW.

Check the content of the disc before format. If you format the disc, the recorded content of the disc will be erased.

To format a DVD in the Video mode, select "REFORMAT AS DVD VIDEO", and to format it in the VR mode, select "REFORMAT AS DVD VR". For more information see page 10.

The screen below will appear.

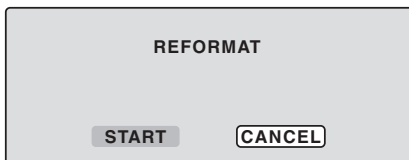

- When you select "START" and press **ENTER**, format will start. The screen below will appear.

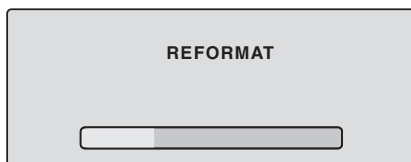

- When you select "CANCEL" and press **ENTER**, the DISC SETUP screen will appear.

Note

- You cannot reformat DVD-R.
- You cannot reformat a disc if the disc protection is "ON".

In such a case, be sure to cancel the disc protection (see page 28) before formatting.



FINALIZE

To play a DVD disc recorded on this unit you must finalize the disc to insure compatibility with other DVD players. In addition if you are using a DVD-RW disc you must record in Video mode.

When "FINALIZE" is selected, the screen below will appear.

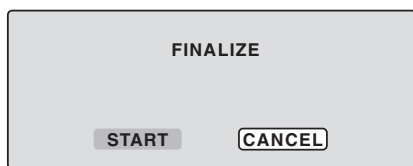

- When you select "START" and press **ENTER**, finalization will start. The screen below will appear.

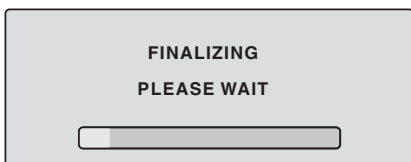

- When you select "CANCEL" and press **ENTER**, the DISC SETUP screen will appear.



Note

- During the finalization the cursor will move repeatedly. When the finalization finished, "DISC FINALIZED" will appear.
- The finalization process may require a few minutes to about 1 hour according to disc type or the amount of free space on the disc.
- You can record or edit a finalized DVD-RW (in VR mode) by cancelling the finalizing, but you cannot do these operations with a DVD-RW (Video mode), or with a DVD-R.
- You cannot playback a disc recorded on VR mode on a unit that does not support DVD-RW.
- Even if you finalize a disc in the Video mode, the disc cannot be played back in some DVD players.
- A DVD-R disc cannot be named after it is finalized.

PROTECT DISC

You can protect a disc to prevent the content recorded on it from being erased, edited or re-recorded. Only DVD-RW (in VR mode) can be protected. Select "PROTECT DISC" and select "ON" to protect the disc.

To cancel the disc protection, select "OFF".

UNDO FINALIZE

You can cancel the finalization of a finalized DVD-RW (in VR mode).

You cannot cancel the finalization for discs other than above. You can record or edit on a disc whose finalization has been cancelled.

Select "UNDO FINALIZE", and the screen below will appear.

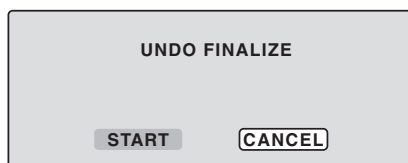

- When you select "START" and press **ENTER**, the cancelling finalization will start. The screen below will appear.

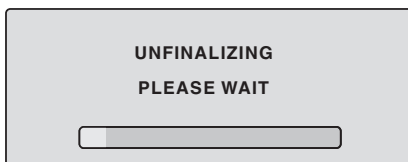

- When you select "CANCEL" and press **ENTER**, the DISC SETUP screen will appear.



Note

- During the cancelling finalization the cursor will move repeatedly.
- The cancelling finalization process may require a few minutes to about 1 hour according to disc type or the amount of free space on the disc.
- When the disc's finalization cannot be cancelled, you cannot select "UNDO FINALIZE".

You can turn the display window and screen display "ON" or "OFF".

Preparation:

- Turn ON the TV and set it to the video input mode.
- Select "**OTHER**" from "**SYSTEM SETUP**". For the procedure, see steps **1** to **3** in "Using the SETUP MENU" on page 23.

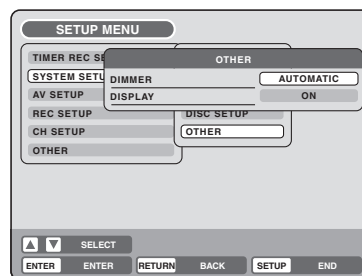



DIMMER (Brightness of the display window)

You may adjust the brightness or turn off the display on the front panel of the unit.

Select "DIMMER" and select the display window status from the list below.

AUTOMATIC:

When the power is on, the display window appears bright. When the power is off, it appears dark.

DIM:

The window display always appears dark.

OFF:

When the power is on, the display window appears dark. When the power is off, it is turned off.

DISPLAY (Turning the screen display "ON" or "OFF")

You can turn off the screen display that is output to the TV screen by this unit. Select "DISPLAY", and select "ON" or "OFF".

ON:

The screen display appears.

OFF:

Nothing but the SETUP MENU and error messages appear.

TV SCREEN

You can select the TV screen size to suit the screen image.

Select "TV SCREEN" and select screen size from the list below.

4:3 Pan scan

It displays a wide picture across the whole screen with left and right edges automatically cut off.

4:3 Letter box

Select this mode when connecting to a conventional TV. When playing back a wide screen DVD disc, it displays a wide picture with black bands at the top and bottom of screen.

16:9

Select this mode when connecting to a wide-screen TV. A wide-screen picture is displayed in full size.



Note

- For the screen sizes and disc formats, see page 81.
- If the DVD disc is not formatted in the pan scan format, it displays a 4:3 aspect ratio.

STILL MODE

You can set the type of image displayed on the TV screen when the playback of the DVD is stilled. Select "STILL MODE" and select the image to be displayed from the list below.

AUTOMATIC

The field still or frame still is automatically selected. (For normal use.)

STILL BY FRAME

The frame still is set.

Note for the field still and frame still:

(with 480i interlaced scanning mode)

- Field* still (240 lines)
Since only one field (half of the video information) is shown on the TV screen, the picture appears rough but does not shake.
- Frame* still (480 lines)
Two fields are alternatively shown on the TV screen. The picture shakes but the resulting picture quality is superior to the field still pictures.

Field*: A field refers to the video information in one-half of a frame. 1 frame (screen) consists of 2 fields.

Frame*: A frame refers to the total area occupied by each picture on the TV screen.

Setting the screen

This section describes settings about the screen.

Preparation:

- Turn ON the TV and set it to the video input mode.
- Select "AV SETUP 1" from "AV SETUP". For the procedure, see steps 1 to 3 in "Using the SETUP MENU" on page 23.

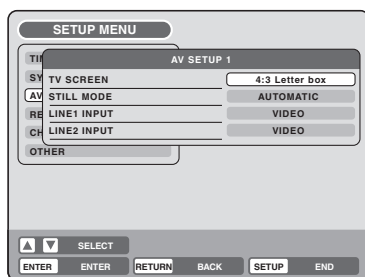

LINE1 INPUT/LINE2 INPUT

This unit comes with an S-Video input jack and Video input jack. When you use an S-Video or Video input jack, you must select the input mode. Select "LINE1 INPUT" ("LINE2 INPUT") and select the mode from the following list.

S-VIDEO (for DVD only)

The video signal is input only from the S-Video input jack.

VIDEO

The video signal is input only from the video input jack.



Note

- You can't record the S-video input signal to video tape.

Setting the image quality

This section describes image quality settings.

Preparation:

- Turn ON the TV and set it to the video input mode.
- Select "AV SETUP 2" in "AV SETUP". For the procedure, see steps **1** to **3** in "Using the SETUP MENU" on page 23.

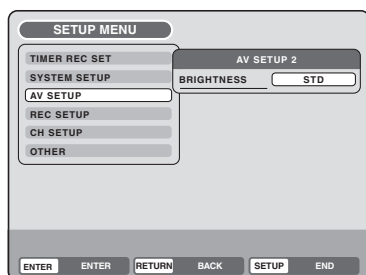

BRIGHTNESS

You can control the brightness level of the image. Select "BRIGHTNESS" and select the level from the list below.

- MAX:** The image becomes brighter.
- STD:** The image is of standard brightness.
- MIN:** The image becomes darker.

Setting the audio

This section describes audio settings.

Preparation:

- Turn ON the TV and set it to the video input mode.
- Select "AUDIO" from "AV SETUP". For the procedure, see steps **1** to **3** in "Using the SETUP MENU" on page 23.

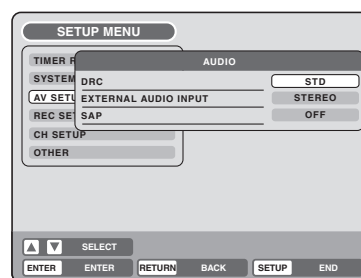

DRC

DRC (Dynamic Range Control) enables you to control the dynamic range so as to achieve a suitable sound for your equipment.

Select "DRC" and select the level from the list below.

- MAX:** Full dynamic range is maintained.
- STD:** Full dynamic range is reduced.
- TV:** Dynamic range is reduced.



Note

- This function works only during playback of Dolby Digital recorded discs.
- When you listen to the sound from TV's speaker, we recommend that you select "TV".
- The level of Dynamic Range Reduction may differ depending on the DVD.



EXTERNAL AUDIO INPUT

The audio mode for the audio input jack can be selected, choosing either stereo or monaural. Select "EXTERNAL AUDIO INPUT" and select from the list below.

STEREO:

The sound is treated as stereo sound.

L CH:

The sound is treated as the monaural sound of the left channel.

R CH:

The sound is treated as the monaural sound of the right channel.

SAP (Second Audio Program)

This unit is fitted with a SAP broadcast system that enables you to switch to a second audio program while viewing a selected channel.

This function applies only when the program is broadcast in multiple languages through the SAP broadcast system.

Select "SAP" and select "ON" to use SAP, and to not use it, select "OFF".

Listening to SAP

When the unit is turned on or a channel selection is made, make certain the letters "SAP" appear on the screen. This means that "Second Audio Program" broadcasting is available.

Setting the recording

This section describes recording settings.

Preparation:

- Turn ON the TV and set it to the video input mode.
- Select "REC SETUP". For the procedure, see steps 1 to 3 in "Using the SETUP MENU" on page 23.

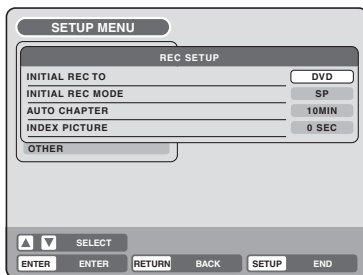

INITIAL REC TO

You can select the recording media that is first displayed in the item "REC TO" on the timer recording screen.

Select "INITIAL REC TO" and select "DVD" or "VCR".

INITIAL REC MODE

You can select the recording mode that is first displayed in the item "REC MODE" on the timer recording screen.

Select "INITIAL REC MODE" and select XP, SP, LP, or EP.

Note

- For the DVD recording mode, see page 52. And for the VCR recording mode, see page 48.

AUTO CHAPTER

You can automatically make chapter marks on the DVD to be recorded.

Select "AUTO CHAPTER" and select the interval between chapter marks from the list below.

OFF: Automatic chapter marking is not used.

5 MIN: The interval is set to 5 minutes.

10 MIN: The interval is set to 10 minutes.

15 MIN: The interval is set to 15 minutes.

30 MIN: The interval is set to 30 minutes.

INDEX PICTURE

You can set the time that the thumbnail image is registered in the title menu of DVD-RW (VR mode).

Select "INDEX PICTURE" and select from the list below.

0 SEC: The image of a recording start point is registered.

1 MIN: The image 1 minute after a recording start is registered.

3 MIN: The image 3 minutes after a recording start is registered.

Note

- You cannot select the thumbnail image for Video mode.

Setting the channel

This DVD/VCR is equipped with a channel memory feature that allows you to skip channels up or down to the next channel set in memory, hence skip over unwanted channels.

Before selecting channels, they must be programmed into the DVD/VCR's memory. In addition to normal VHF and UHF channels, this DVD/VCR can receive up to 113 Cable TV channels. To use this DVD/VCR with an antenna, set the TV/CABLE menu option to the TV mode. When shipped from the factory, this menu option is in the CABLE mode.

Preparation:

- Turn ON the TV and set it to the video input mode.
- Select "**CH SETUP**". For the procedure, see steps **1** to **3** in "Using the SETUP MENU" on page 23.

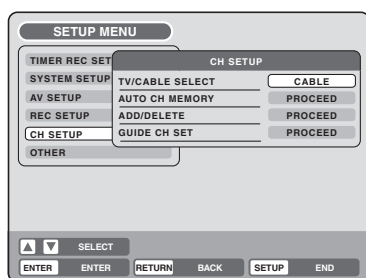

TV/CABLE SELECT

Select "TV/CABLE SELECT" and select "TV" or "CABLE".

- TV:** VHF/UHF channels
- CABLE:** CABLE TV channels

AUTO CH MEMORY

The VCR can receive a maximum of 181 channels by presetting the channels into memory.

When you select "AUTO CH MEMORY" and press **ENTER**.

The AUTO CH MEMORY function will be activated. The channel display will count up and, when finished, the screen returns to normal.

ADD/DELETE (channels)

You can add the channels you want or delete the channels you do not want manually. Select "ADD/DELETE" and select "ADD" or "DEL." for each channel.

- Press **▲** or **▼** to select the channel. The **numeric keys** can also be used for selection.
- When you want to delete the selected channel, press **▶** to select "DEL" and press **ENTER**.
- When you want to use the selected channel, press **◀** to select "ADD" and press **ENTER**.

Setting other items

You can set the switching interval between played back images in the slide show mode.

Preparation:

- Turn ON the TV and set it to the video input mode.
- Select "**OTHER**". For the procedure, see steps **1** to **3** in "Using the SETUP MENU" on page 23.

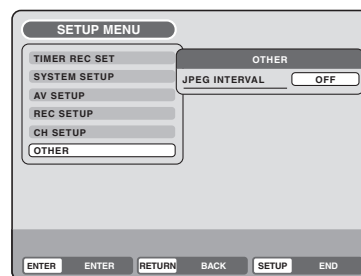

JPEG INTERVAL

You can select the interval time for JPEG slide show (page 46).

Select "JPEG INTERVAL" and select the switching interval between images from the list below.

- OFF:** The slide show mode is not used.
- 5 SEC:** The interval is set to 5 seconds.
- 10 SEC:** The interval is set to 10 seconds.
- 15 SEC:** The interval is set to 15 seconds.



Chapter 5 Playback

Playback procedure

DVD-Video VR mode Video mode DVD-R CD

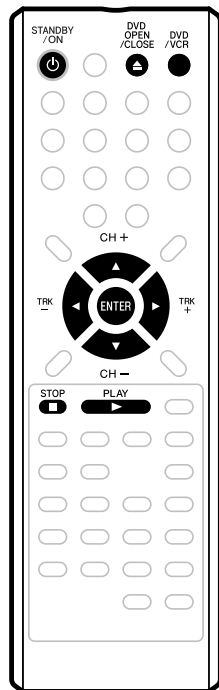

Preparation:

- Turn ON the TV and set to the video input mode.
- Press **DVD/VCR** to select the DVD mode. (The DVD indicator will light.)

1 Press OPEN/CLOSE.

The disc tray will open.

2 Place a disc onto the tray.

Hold the disc, position it with the printed label side up, align it with the guides, and place it in its proper position.

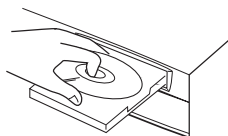

3 Press OPEN/CLOSE to close the disc tray.

"READING" appears on the screen and some discs start playback automatically.

- A menu screen may appear on the TV screen, if the disc has a menu feature. In this case, press **▲**, **▼**, **◀**, **▶** or **ENTER** to operate a menu feature.

4 Press PLAY to start playback.

5 Press STOP to end playback.

- The DVD/VCR memorizes the stopped point, depending on the disc. "■" appears on the screen for approx. 4 seconds. "▶" keeps blinking in the display until the playback is stopped completely. Press **PLAY** to resume playback (from the scene point).
- If you press **STOP** again ("■" appears on the screen), the DVD/VCR will clear the stopped point.

6 Then press OPEN/CLOSE.

The disc tray opens. Remove the disc and press **STANDBY/ON**. The disc tray closes automatically and the DVD/VCR turns off.

Note

- If a non-compatible disc is loaded, "INCORRECT DISC", "REGION CODE ERROR" or "PARENTAL ERROR" will appear on the TV screen according to the type of loaded disc. In this case, check your disc again (See pages 9 and 25).
- Some discs may take a minute or so to start playback.
- A prohibition symbol "⊘" may appear at the upper right of the screen. This symbol means either the feature you tried is not available on the disc, or the DVD/VCR can not access the feature at this time. This does not indicate a problem with the DVD/VCR.
- When you set a single-faced disc label downwards (ie. the wrong way up) and press **PLAY** or **OPEN/CLOSE**, "READING" will appear and then it will change to "NO DISC".
- Some playback operations of DVDs may be intentionally fixed by software producers. Since this DVD/VCR plays DVDs according to the disc contents the software producers designed, some playback features may not be available. Also refer to the instructions supplied with the DVDs.
- When playing DTS-encoded Audio CDs, excessive noise will be heard from the analog stereo outputs. To avoid possible damage to the audio system, the consumer should take proper precautions when the analog stereo outputs of the DVD/VCR are connected to an amplification system.
- Playability of 'DualDisc'
 - The DVD-Audio content on DVD side of a DualDisc cannot be played with this product.
 - The DVD-Video content on DVD side of a DualDisc may or may not be played with this product.
 - Since audio content on 'non-DVD' side of a DualDisc is not compliant with the Compact Disc Digital Audio specification, it may or may not be played with this product.
 - If you need further information about playability of DualDisc, please see 'Service & Support' on the Pioneer web site (www.pioneerelectronics.com).



Playback by selecting a title

VR mode **Video mode** **DVD-R**

When playing back a recorded disc, you can display the title menu and select the title to be played back.

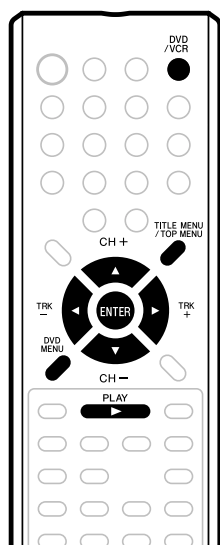

2 Press ▲ or ▼ to select the title you want to playback.

In case the disc includes more than 10 titles, you can turn to the next or the previous page. Press ◀, then press ▼ or ▲ to display next/previous page. To return to normal use, press ▶.

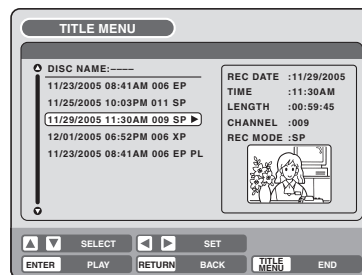

3 Press ENTER.

The selected title is played back.



Note

- If you don't display the title menu and press **PLAY**, the first title is played back.
- When a title is played by selecting it from the title menu, only the title selected is played.
- When a disc that has been recorded in the Video mode is finalized, a title list is automatically created that can be played back even with other DVD players. Consequently, the menu before finalizing is different from that of after finalizing.

Preparation:

- Turn ON the TV and set to the video input mode.
- Load a recorded DVD.
- Press **DVD/VCR** to select the DVD mode. (The DVD indicator will light.)

1 Press TITLE MENU.

The title menu will appear.

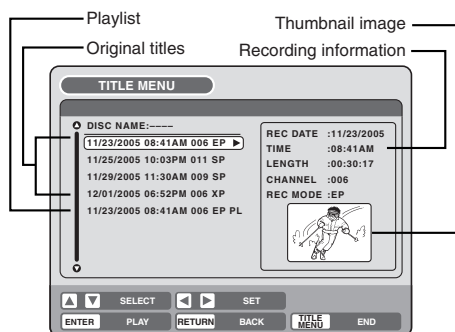

If there are many original titles and playlists... Before pressing **TITLE MENU**, press **DVD MENU** until "VR ORG" or "VR PL" will appear on the upper right of the TV screen, then press **TITLE MENU**. The first original title or playlist will be highlighted.

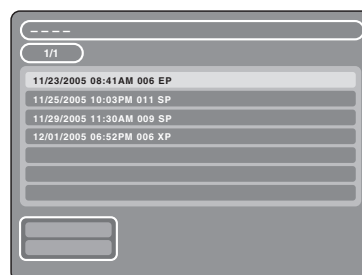

- The title menu is used not only for playing back titles but also for editing various discs and titles. For details of editing operation, see page 63.
- If you create a playlist, an original title and playlist appear in the title menu. For creating a playlist, see page 64.
- You cannot switch to the VCR mode when the title menu is showing. Press **TITLE MENU** to clear the title menu, then press **DVD/VCR** to switch to the VCR mode.
- The recording information of discs that have been recorded on other recorders may not be displayed.



Checking media information

DVD-Video **VR mode** **Video mode** **DVD-R**

Various information on the loaded disc can be displayed on the TV screen.

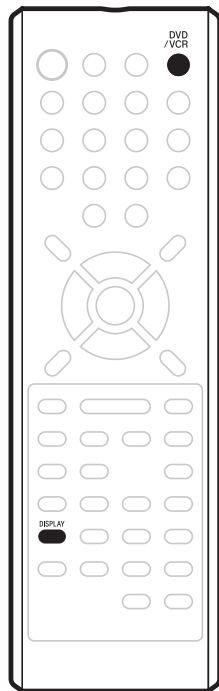

1 Press DISPLAY.

Media information will appear.

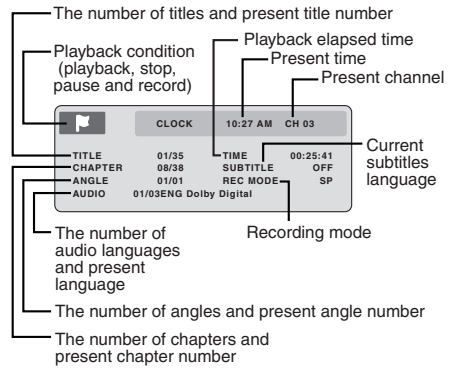

In stop mode, some information does not appear.

2 Press DISPLAY while the media information above is displayed. The next media information will appear.

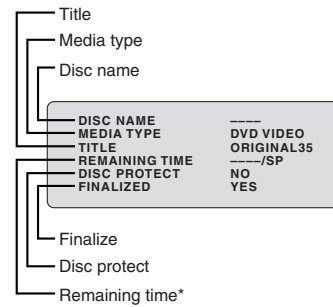

*The remaining time displayed during recording may be different from the actual remaining time. When you want to check the remaining time, stop recording and display the media information again.

3 Press DISPLAY again while the media information above is displayed. The media information will disappear.

Note

- The displayed information varies with the type of media.
- Some information may not appear due to media type or operating conditions.

Preparation:

- Turn ON the TV and set it to the video input mode.
- Load the disc.
- Press **DVD/VCR** to select the DVD mode. (The DVD indicator will light.)





Special playback

DVD-Video VR mode Video mode DVD-R CD

Note

- There may be a slight delay between pressing the button and the function activation.
- The unit is capable of holding a still video image or On screen display image on your television screen indefinitely. If you leave the still video image or On screen display image displayed on your TV for an extended period of time, you risk permanent damage to your television screen. Projection televisions are very susceptible.
- Fast forward and review playback does not work with a MP3/WMA/JPEG-CD.
- Frame advance and slow motion does not work with a CD.

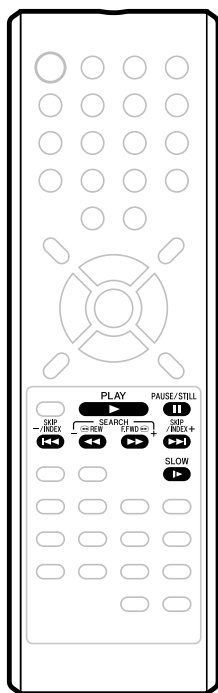

Fast forward playback

Press **F.FWD** during normal playback. Each press of **F.FWD** will increase the speed of the search ►► (x2), ►►► (x12), ►►►► (x24), ►►►►► (x60).

(The speed of the search is increased up to only 2 steps in Audio CD.)

- To resume normal playback, press **PLAY**.

Review playback

Press **REW** during normal playback. Each press of **REW** will increase the speed of the search ◀◀ (x2), ◀◀◀ (x12), ◀◀◀◀ (x24), ◀◀◀◀◀ (x60).

(The speed of the search is increased up to only 2 steps in Audio CD.)

- To resume normal playback, press **PLAY**.

Still playback

Press **PAUSE/STILL** during normal playback.

- To resume normal playback, press **PLAY**.

Frame advance

Press **PAUSE/STILL** during still playback. One frame is advanced each time you press **PAUSE/STILL**.

- To resume normal playback, press **PLAY**.

Slow motion playback

Press **SLOW** during normal playback or still playback. Each press of **SLOW** will change the speed of the slow "►► 1/2", "►► 1/4", "►► 1/8".

- To resume normal playback, press **PLAY**.
- To resume the still playback, press **PAUSE/STILL**.

Locating a chapter or track

Press **SKIP** (►►) Forward or **SKIP** (◀◀) Reverse during playback to locate a chapter that you want to watch. Each time you press the button, a chapter or track is skipped.



Commercial skip / Locating a specific scene

DVD-Video VR mode Video mode DVD-R

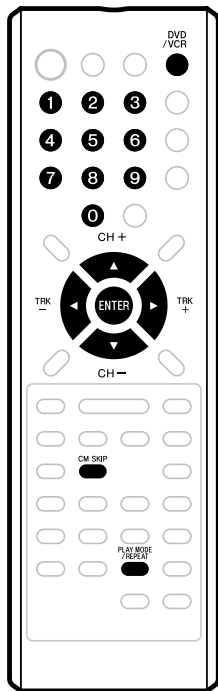

Locating a specific scene

Specify the time recorded on the disc, chapter or title to playback.

1 Press PLAY MODE.

The play mode screen will appear.



2 Press ◀ or ▶ to select "TIME SEARCH", "CHAPTER SEARCH" or "TITLE SEARCH", and press ENTER.

TIME SEARCH:

Input the time until the playback is restarted.

CHAPTER SEARCH:

Select the chapter number to be played back.

TITLE SEARCH:

Select the title number to be played back.

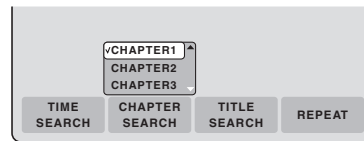

The screen above is displayed when "CHAPTER SEARCH" is selected.

3 When selecting "TIME SEARCH", input the time until the playback is restarted with the numeric keys. When selecting "CHAPTER SEARCH" or "TITLE SEARCH", press ▲ or ▼ to select the chapter number or title number.

4 Press ENTER.

The playback starts at the point you selected.

Note

- You cannot switch to the VCR mode when the play mode screen is showing. Press **PLAY MODE** to clear the play mode screen, then press **DVD/VCR** to switch to the VCR mode.
- For "REPEAT", see "Title, Chapter repeat playback" (page 38).

Commercial skip

Use this function to skip commercials while you playback.

Press **CM SKIP** during playback. The time jumps to a point approximately 30 seconds later and playback resumes.

Note

- With some DVD-Video, the Commercial skip operation may not work.



Repeat playback

DVD-Video VR mode Video mode DVD-R CD

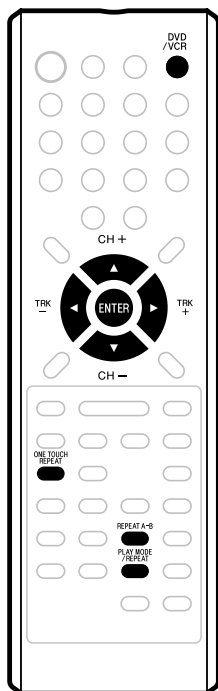

Note

- Some discs may not work with the repeat operation.
- If the time from the title top is less than 10 seconds when **ONE TOUCH REPEAT** is pressed, the title top is repeated and then the video is played back.
- With some DVD-Video, the one touch repeat operation may not work.
- In A-B repeat mode, subtitles near point A or B may not appear.
- A-B repeat does not work during the Title and the Chapter repeat playback.
- You may not be able to set A-B repeat, depending on the scenes of the DVD.
- A-B repeat and Title, Chapter repeat does not work with an MP3/WMA/JPEG-CD.
- You cannot switch to the VCR mode when the play mode screen is showing. Press **REPEAT** to clear the play mode screen, then press **DVD/VCR** to switch to the VCR mode.
- One touch repeat and Title, Chapter repeat playback does not work with a CD.

One touch repeat

This feature can be used to repeat the last 10 seconds of viewed material, then playback as normal.

Press **ONE TOUCH REPEAT** during playback. The video returns to a point 10 seconds before and playback resumes.

A-B repeat playback

A-B repeat playback allows you to repeat material between two selected points.

1 Press REPEAT A-B during playback.

The start point is selected.



2 Press REPEAT A-B again.

The end point is selected. Playback starts at the point that you selected. Playback stops at the end point, returns to point A automatically, then starts again.



To resume normal playback press **REPEAT A-B** again. "OFF" appears on the screen.

Title, Chapter repeat playback

1 Press REPEAT.

The play mode screen will appear.



2 Press ◀ or ▶ to select "REPEAT" and press ENTER.



3 Press ▲ or ▼ to select "OFF", "CHAPTER" or "TITLE" from the list.

OFF:

Playback is not repeated.

CHAPTER:

The chapter in playback is repeatedly played back.

TITLE:

The title in playback is repeatedly played back.

4 Press ENTER.

To cancel the repeat playback, select "OFF" in step 3.



Title selection / DVD menu

DVD-Video

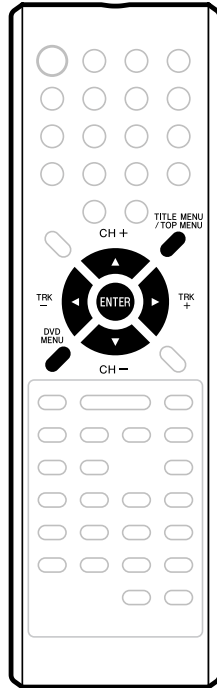

DVD menu

Some DVDs allow you to select the disc contents using the menu. When you playback these DVDs, you can select the subtitles language, soundtrack language, etc. using the DVD menu.

1 Press DVD MENU during playback.

The DVD menu appears on the screen.

- Press **DVD MENU** again to resume playback at the scene when you pressed **DVD MENU**.

2 Press ▲ / ▼ or ◀ / ▶ to select the desired item.

3 Press ENTER.

The menu continues to another screen. Repeat steps 2 and 3 to set the item completely.

Title selection

Two or more titles are recorded on some discs. If the title menu is recorded on the disc, you can select the desired title.

1 Press TITLE MENU/TOP MENU during playback.

The title menu appears on the screen.

- Press **TITLE MENU/TOP MENU** again to resume playback at the scene when you pressed **TITLE MENU/TOP MENU**.

2 Press ▲ / ▼ or ◀ / ▶ to select the desired title.

3 Press ENTER.

The playback of the selected title will start.



Note

- Depending on the DVD, you may be unable to select the title, and a "title menu" may simply be called a "menu" or "title" in the instructions supplied with the disc.

Changing angles / Zooming

DVD-Video VR mode Video mode DVD-R

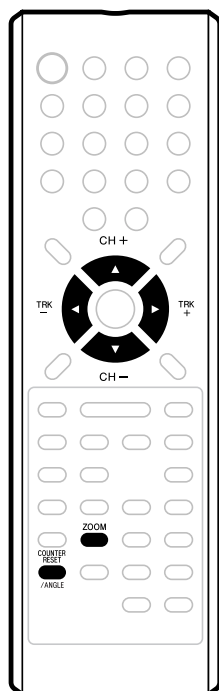

Note

- Depending on the DVD, you may not be able to change the angles even if multi-angles are recorded on the disc.
- You can use the Pause, Slow, Search or Skip feature in the zoom mode.

Changing angles

When playing back a disc recorded with multi-angle facility, you can change the angle that you are viewing the scene from.

- 1 Press ANGLE during playback.**
The current angle will appear.
- 2 Press ANGLE repeatedly until the desired angle is selected.**

Zooming

This unit will allow you to zoom in on the frame image. You can then make selections by switching the position of the frame.

- 1 Press ZOOM during playback.**
The center part of the image will be zoomed in. Each press of ZOOM will change the ZOOM "x2", "x3" and "x4".

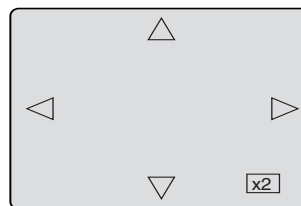

- 2 Press ▲ / ▼ or ◀ / ▶ to view a different part of the frame.**
You may move the frame from the center position to UP, DOWN, LEFT or RIGHT direction.
- 3 In the zoom mode press ZOOM repeatedly to return to a 1:1 view "x1".**



Changing soundtrack language / Subtitles

DVD-Video

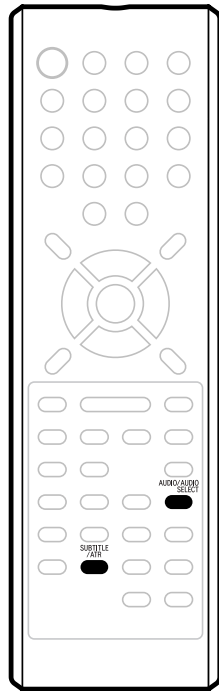

Changing soundtrack language

You can select the language when you play a multilingual disc.

1 Press AUDIO during playback.

The current soundtrack language will appear.

2 Press AUDIO repeatedly until the desired language is selected.

The on-screen display will disappear after a few seconds.

Turning the subtitles On and Off

When playing back a disc recorded with subtitles, you can turn the subtitles on or off.

Press **SUBTITLE** during playback until "Subtitle OFF" appears.

Changing the subtitle language

You can select the language when playing back a disc recorded with multilingual subtitles.

Press **SUBTITLE** repeatedly during playback until your desired language appears.

The on-screen display will disappear after a few seconds.

Note

- If the desired language is not heard after pressing the button several times, the language is not recorded on the disc.
- Changing soundtrack or subtitle language is cancelled when you open the disc tray. The initial default language or available language will be heard and seen if the disc is played back again.
- Depending on the DVD you may be unable to turn on, turn off, or change the subtitles, even if they are recorded on the disc. While playing the DVD, the subtitles may change while opening or closing the disc tray, or while changing the title.
- In some cases, the subtitles language is not changed to the selected one immediately.

The CD Track Info screen

CD

This section describes the TRACK INFO screen where music CDs can be played back using the various operations.

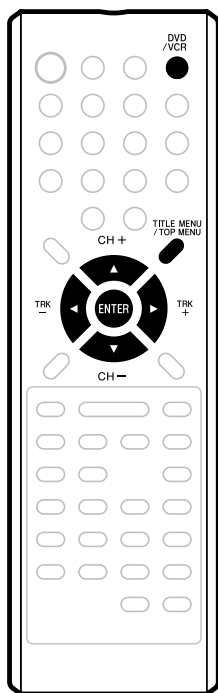

Note

- In case the disc includes more than 10 tracks, you can turn to the next or the previous page. Press ◀, then press ▼ or ▲ to display next/previous page. To return to normal use, press ▶.
- You cannot switch to the VCR mode when the TRACK INFO screen is showing. Press **TITLE MENU/TOP MENU** to clear the TRACK INFO screen, then press **DVD/VCR** to switch to the VCR mode.

Preparation:

- Turn ON the TV and set to the video input mode.
- Load the music CD.
- Press **DVD/VCR** to select the DVD mode. (The DVD indicator will light.)

Press **TITLE MENU/TOP MENU**.

The TRACK INFO screen will appear.

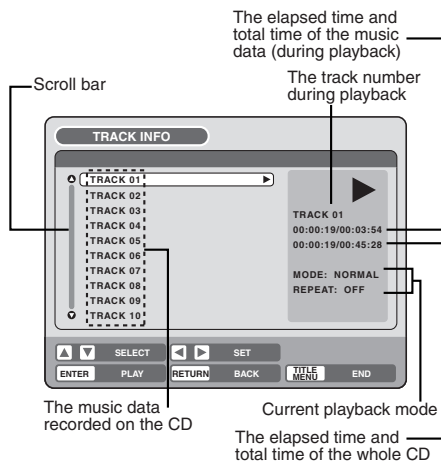

Press ▶. The menu list will appear.

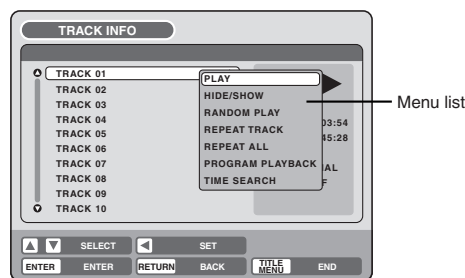

Playing back a selected track

- 1 Press ▲ or ▼ to select the track number you want to playback and press ▶.
- 2 Press ▲ or ▼ to select "PLAY" from the menu list and press ENTER.
The selected track will be played back.

Excluding specified track

- 1 During stop, press ▲ or ▼ to select the track number you do not want to playback and press ▶.
- 2 Press ▲ or ▼ to select "HIDE/SHOW" from the menu list and press ENTER.
The selected track will not be played back. ("H" appears at the side of the track number.)

When you want to cancel the exclusion, press ▲ or ▼ to select the track number with "H" and press ▶. Press ▲ or ▼ to select "HIDE/SHOW" from the menu list and press **ENTER**, "HIDE" will be cancelled.



Random, repeat and program play

CD

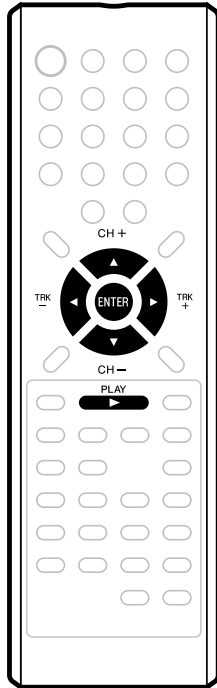

Note

- "RANDOM PLAY" and "TIME SEARCH" will not appear in the menu list for CD-R/CD-RW discs containing MP3 or WMA files.

Random playback

1 Press ▲ or ▼ to select "RANDOM PLAY" from the menu list and press ENTER.

2 Press PLAY.

Music is played back in random order.

To cancel random playback, select "RANDOM PLAY" from the menu list again, and press **ENTER**.

Repeat playback of selected track

1 Press ▲ or ▼ to select the track number you want to repeat playback and press ►.

2 Press ▲ or ▼ to select "REPEAT TRACK" from the menu list and press ENTER.

3 Press PLAY.

The selected track will be played back repeatedly.

To cancel repeat track playback, select "REPEAT TRACK" from the menu list again, and press **ENTER**.

Repeat playback of all tracks

1 Press ▲ or ▼ to select "REPEAT ALL" from the menu list and press ENTER.

2 Press PLAY.

All tracks on CD will be played back repeatedly.

To cancel the repeat all playback, select "REPEAT ALL" from the menu list again, and press **ENTER**.

See also A-B Repeat on page 38.

Playing back programs

You can specify the playback order yourself.

1 Press ▲ or ▼ to select "PROGRAM PLAYBACK" from the menu list and press ENTER.

2 Press ▲ or ▼ to select to the track number that you want to change the order of and press ENTER.

The "►" mark will appear at the right side of the track number.

3 Press ▲ or ▼ to select to the track number that you want to specify and press ENTER.

The track number that you select in step 2 moves to the position that you specified.

4 Repeat steps 2 and 3 to change the playback order.

5 Press PLAY.

The tracks will be played back in the changed order.

To cancel program playback, select "EXIT PROGRAM MODE" from the menu list and press **ENTER**.

Playing back track by specifying the time

1 Press ▲ or ▼ to select "TIME SEARCH" from the menu list during playback and press ENTER.

2 Press ▲ / ▼ or ◀ / ▶ to specify the elapsed time of the track (this will be the starting point of playback) and press ENTER.

Playback will start from the specified elapsed time.



MP3/WMA/JPEG playback

WMA and JPEG files can only be played back with RT501.

CD

MP3 and WMA files can be played back. Also, you can display JPEG files on the TV screen and enjoy them as a slide show.

Some discs may not play due to the condition of the recording.

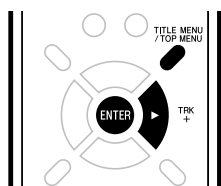

Limitations on MP3/WMA/JPEG CD playback:

- MP3/WMA/JPEG CD is a disc that is standardized by ISO9660.
- The directory and file names of the MP3/WMA/JPEG CD must correspond to the ISO standardized file names.
- This unit can read 200 files per disc. If one directory has more than 200 files, it reads up to 200 files, the remaining files will be omitted.
- The unit is able to recognize up to a maximum of 50 directories per disc.
- MP3/WMA CDs cannot be used for playback for the purpose of recording.
- MP3/WMA/JPEG CDs may be used for playback, but not for recording.
- If the CD has both audio tracks and MP3/WMA/JPEG files, only audio tracks are played.
- It may take more than one minute for this unit to read MP3/WMA/JPEG files depending on its structure.
- Music recorded by "Joliet Recording Specification" can be played back. Long file names will be cut.
- The music files recorded by "Hierarchical File System" (HFS) cannot be played.

Preparation:

- Turn ON the TV and set to the video input mode.
- Load the disc storing MP3, WMA or JPEG.
- Press **DVD/VCR** to select the DVD mode. (The DVD indicator will light.)

Using the BROWSER screen

1 Press TITLE MENU.

The BROWSER screen will appear.

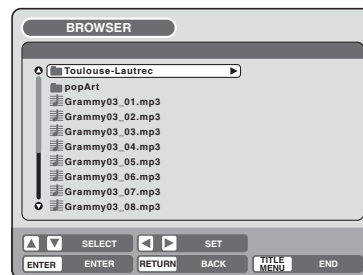

2 The MP3, WMA and JPEG files and folders stored in the disc are displayed on the BROWSER screen.

- Select a folder and press **ENTER**. The files in the folder appear.

When the file to be displayed is selected

You can select the file types to be displayed on the BROWSER screen.

1 Press ► to select "SELECT FILES" and press ENTER.

The following list will appear.

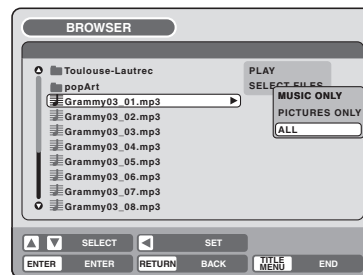

MUSIC ONLY:

Only the MP3 and WMA files appear.

PICTURES ONLY:

Only the JPEG files appear.

ALL:

All files and folders appear.

2 Select one item in the above list and press ENTER.

The display will be changed to the selected display type.



Playing back MP3/WMA files

MP3 CD

- MP3 files must have the extension letters “.mp3”.
- Standard, sampling frequency, and the bit rate: MPEG-1 Audio
32kHz, 44.1kHz, 48kHz
32kbps to 320kbps (constant bit rate or variable bit rate)
- The recommended recording setting for high quality sound is 44.1kHz sampling frequency and 128kbps of constant bit rate.

WMA CD

WMA and JPEG files can only be played back with RT501.

- When creating a WMA disc, make sure that the copyright function is off. DRM (Digital Rights Management) files cannot be played back.
- WMA files must have the extension letters “.wma”.
- Standard, sampling frequency, and the bit rate: WMA version 7 and 8
32kHz, 48kbps
44.1kHz, 48kbps to 192kbps
48kHz, 128kbps to 192kbps
- Music files recorded as mono, 48kHz, 48kbps cannot be played back in this unit.

1 Press ▲ or ▼ to select MP3 or WMA file.

- In case the disc includes more than 10 files, you can turn to the next or the previous page. (See page 42.)

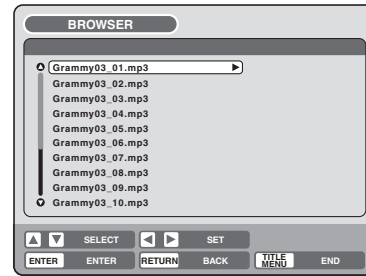

2 Carry out either of the item a or b below.

a: Press **ENTER**.

b: Press ► to select “PLAY” and press **ENTER**.

The TRACK INFO screen appears to playback the selected file. For the details of the TRACK INFO screen, see “The CD Track Info screen” on page 42.

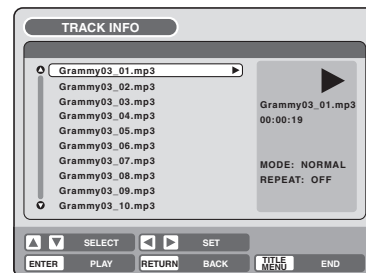

3 To return to the BROWSER screen, press RETURN.

- To stop playback of the MP3 or WMA files, press **TITLE MENU**.

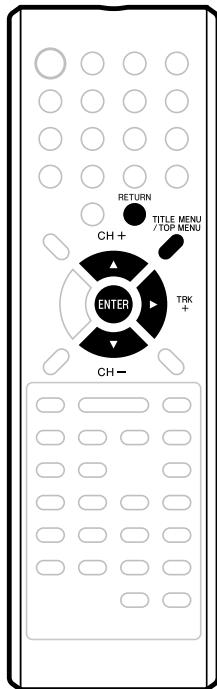



Playing back JPEG files

JPEG files can only be played back with RT501.

JPEG CD

JPEG files must have the extension letters ".jpe", ".jpeg" or ".jpg".

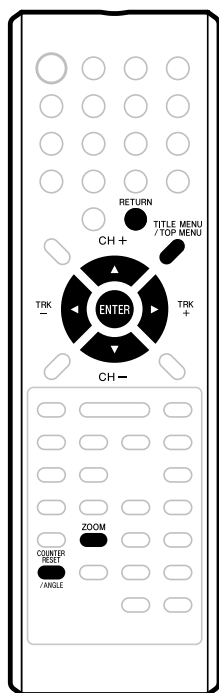

1 Press ▲ or ▼ to select JPEG file.

- In case the disc includes more than 10 files, you can turn to the next or the previous page. (See page 42.)

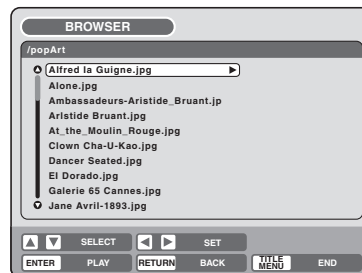

2 Carry out either of the item a or b below.

a: Press **ENTER**.

b: Press ► to select "PLAY" and press **ENTER**.

The thumbnail images of the JPEG files stored in the route directory or the folder appear.

Press ▲, ▼, ◀ or ▶ to select the pages of the thumbnail images, or select the JPEG file to be displayed at first for the slide show.

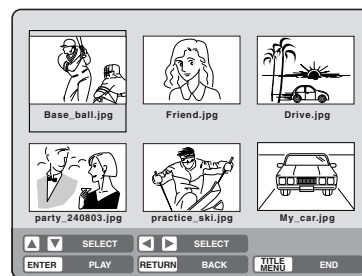

3 Press ENTER to play the selected picture.

If you have set the interval time for JPEG slide show, the pictures will be played back one after another automatically. (See page 32.)

- Press **ZOOM** to enlarge the displayed image.
- Press **ANGLE** to rotate the image by 90 degrees each time.

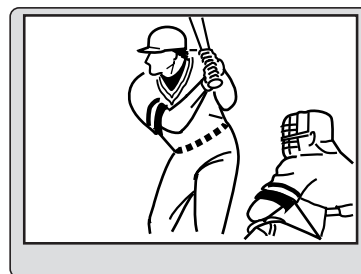

4 To return to the thumbnail screen, press RETURN.

- To stop the slide show, press **TITLE MENU**.



Progressive scan

DVD-Video VR mode Video mode DVD-R

The unit supports the progressive scanning system as well as the conventional interlaced scanning system. If your TV is equipped with component video input jacks which support the progressive video input, you can enjoy higher picture quality by making the progressive scanning mode active.

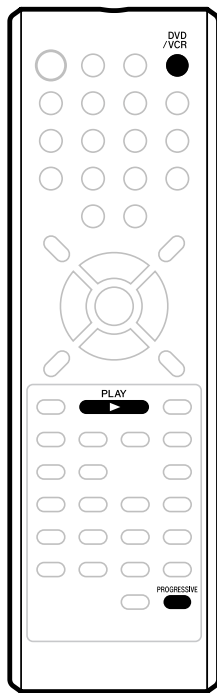

2 Press PLAY to start playback.



- To make the progressive scanning mode inactive, press **PROGRESSIVE** in the stop mode. The PROGRESSIVE indicator "P" on the display window will go off.

Different scanning modes

Interlaced scan

Technology that alternately displays odd-numbered scanning lines and even-numbered scanning lines. Also called "480i", "i" meaning "interlace".

Progressive scan

Technology that simultaneously displays odd-numbered scanning lines and even-numbered scanning lines from top to bottom. Also called "480p", "p" meaning "progressive".

Note

- The progressive scan mode is only available when playing a DVD.
- Some discs may not be played back with the progressive scan mode correctly because of the disc characteristics or recording condition.
- There are some progressive TV and High-Definition TV sets that are not fully compatible with the unit, resulting in an unnatural picture when playing back a DVD disc in the progressive scan mode. In such a case, use the interlaced scanning mode.
- You cannot activate the progressive scan mode in the following cases:
 - the unit is in the VCR mode.
 - a DVD disc is currently playing. You must stop playback first.

Preparation:

- Connect to a TV equipped with component jacks which support progressive video input.
- Turn ON the TV and set it to the corresponding video input mode.
- Press **DVD/VCR** to select the DVD mode. (The DVD indicator will light.)

1 Press PROGRESSIVE in the stop mode. The PROGRESSIVE indicator "P" on the display window will light.

- The unit recognizes the picture source (film or video) of the current disc according to the disc information.

Compatibility of this unit with progressive-scan TVs

Consumers should note that not all high-definition television sets are fully compatible with this product and may cause artifacts to be displayed in the picture. In case of 525 progressive scan picture problems, it is recommended that the user switch the connection to the "standard definition" output (Interlace). If there are questions regarding our TV set compatibility with this model, please contact our customer service center.

This recorder is compatible with the following Pioneer displays and monitors

Plasma display

PDP-505HD, PDP-502MX, PDP-5030HD, PDP-4330HD, Pro-1000HD, Pro-800HD, PDP-5031, PDP-4300, Pro-1000HDI, Pro-800HDI, PDP-5040HD, PDP-4340HD, Pro-1110HD, Pro-910HD, Pro-810HD, Pro-1010HD, Pro-920HD, Pro-1120HD, PDP-4345HD, PDP-5045HD, PDP-4350HD, PDP-5050HD, PDP-4304, PDP-5004, PDP-4300

Projection monitor receiver

Pro-700HD, Pro-710HD, Pro-610HD, Pro-510HD, Pro-720HD, Pro-620HD, Pro-520HD, SD-641HD5, SD-582HD5, SD-532HD5, SD-533HD5, SD-643HD5, Pro-730HD, Pro-630HD, Pro-530HD, Pro-730HDI, Pro-530HDI, Pro-730HD, Pro-630HD, Pro-530HD



05 Playback

Loading and unloading a cassette tape

VCR

Use only video cassette tapes marked **VHS** and **S-VHS**.

SQPB

- Cassettes marked "VHS" (or "S-VHS") can be used with this video cassette recorder. However, S-VHS recording is not possible with this model.
- This model is equipped with SQPB (S-VHS QUASI PLAYBACK) that makes it possible to playback S-VHS recordings with regular VHS resolution.
- HQ VHS is compatible with existing VHS equipment.

Loading

Push the center of the tape until it is automatically inserted.



Insert the cassette tape with its labeled side facing up and the erase prevention tab positioned at your left. An inverted cassette tape cannot be inserted.

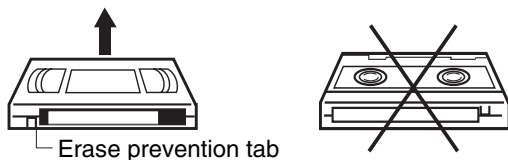

Automatic power ON

When you insert a cassette tape the VCR power will turn ON automatically.

Automatic playback

When loading a cassette tape without an erase prevention tab, playback will start automatically.

Tape speed and maximum recording time

We do not recommend using video tapes longer than 160 minutes.

Tape Speed	Video cassette tape				
	T-160	T-120	T-90	T-60	T-30
SP (Standard Play)	2-2/3 hours	2 hours	1-1/2 hours	1 hour	30 minutes
EP (Expanded Play)	8 hours	6 hours	4-1/2 hours	3 hours	1-1/2 hours

Unloading

You can eject the video tape while the unit is turned off.

- 1 Press EJECT on the unit or the remote control.
- 2 Remove the cassette tape.

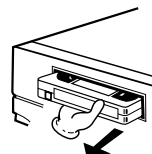

Automatic tape eject

This VCR will automatically rewind the tape when the tape has ended. And when the tape is rewound to its beginning, the cassette tape will be ejected automatically.

To prevent accidental erasure

Remove the erase prevention tab with a screwdriver.

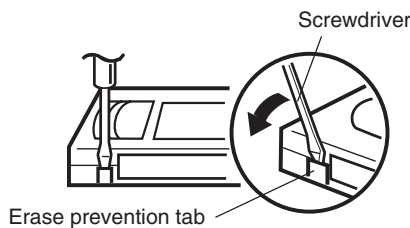

To record again

Cover the hole with a piece of adhesive tape.

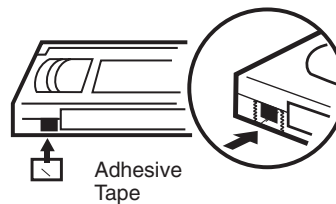



Cassette tape playback

VCR

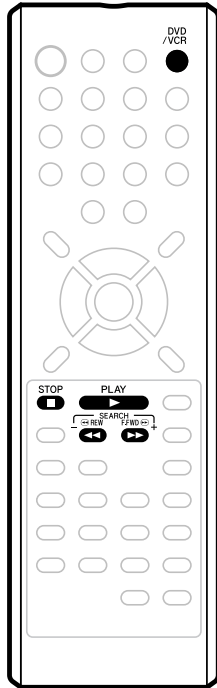

1 Load a prerecorded tape

(When loading a cassette tape without the erase prevention tab, playback will start automatically).

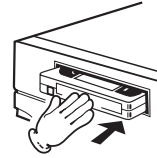

2 To start playback

Press **PLAY**. Playback will start. "▶" will appear on the screen for about 4 seconds.

To stop playback

Press **STOP** once. The tape will stop but remain fully loaded and ready to play. "■" will appear on the screen for about 4 seconds.

To rewind the tape or forward it rapidly

Press **STOP**.

To rewind the tape:

Press **REW**.

To forward the tape:

Press **F.FWD**.

To stop the tape-winding, press **STOP**. To switch to playback directly (without **STOP**), press **PLAY**.

Forward/Reverse picture search mode

When the tape is being wound, you can switch to picture search mode (see next page). To do this, press **REW** or **F.FWD** and hold it down. The unit will resume the tape winding as soon as the button is released.

Note

- This VCR selects the playback tape speed SP, LP or EP automatically.
- A cassette tape and DVD disc can be played back simultaneously. If you press **DVD/VCR**, the tape playback and DVD playback alternate with each other on the screen.

Preparation:

- Turn ON the TV and set to the video input mode.
- Press **DVD/VCR** to select the VCR mode. (The VCR indicator will light.)



Special playback

VCR



Note

- The audio output is muted during SPEED SEARCH, STILL, FRAME ADVANCE and SLOW MOTION.
- During picture search mode there will be noise bars which are caused by the system.
- The Special Playback will automatically change to playback after approx. 5 minutes to protect the video tape against excessive wear.

Picture search

Reverse picture search function

Press **REW** x 1 or x 2 during the playback.

Forward picture search function

Press **F.FWD** x 1 or x 2 during the playback.

To return to playback: Press **PLAY**.

SPEED SEARCH TIMES

TAPE SPEED	PICTURE SEARCH SPEED	
	PRESS ONCE	PRESS TWICE
SP (Standard Play)	3 X	5 X
LP (Long Play)	7 X	9 X
EP (Expanded Play)	9 X	15 X

Still picture

Press **PAUSE** during playback.

To resume normal playback: Press **PLAY** or **PAUSE**.

Slow motion

During playback press **SLOW**.

To return to playback: Press **PLAY** or **SLOW**.

Slow tracking and vertical lock adjustment

If noise bars appear in the picture during slow motion, press the **TRK +** or **-** to reduce the noise bars.

If the still picture jitters excessively, press **TRK +** or **-** to stabilize the still picture.

Frame by frame picture

Press **PAUSE** during playback.

Press **SLOW** one by one: The picture advances frame by frame.

To return to playback: Press **PLAY** or **PAUSE**.

Adjusting tracking condition

Automatic tracking adjustment

Whenever you insert a tape and start playback, automatic tracking starts working and continuously analyzes the signal to enable optimum picture quality during playback.

Manual tracking adjustment

If automatic tracking cannot eliminate noises well during playback, press **TRK + / -** to eliminate the noises. "MANUAL TR." will appear. Press it briefly for a fine adjustment, or press and hold for a coarse adjustment.

- Press **ATR** to reactivate automatic tracking again. "AUTO TR." will appear.

Repeat playback

The entire video tape will be played until its end. The tape will then automatically rewind to the beginning and the playback will be repeated.

1 Press REPEAT while the VCR is playing back.

2 By pressing REPEAT each time, "REPEAT ON" or "REPEAT OFF" is selected in turn.

3 When "REPEAT ON" is selected, the tape is played back to the end, and then, it is automatically rewound to the starting point and played back again.

The display "REPEAT ON" goes out in about 3 seconds. To cancel repeat playback: Press **REPEAT** to select "REPEAT OFF".

Commercial skip

Press **CM SKIP** during playback.

The video is rapidly forwarded for approx. 30 seconds and playback resumes.

You may press the button up to six times in a row to move 180 seconds ahead.

To display VCR operation status

Press **DISPLAY**. The clock, day of the week and more information will be indicated.

While watching TV

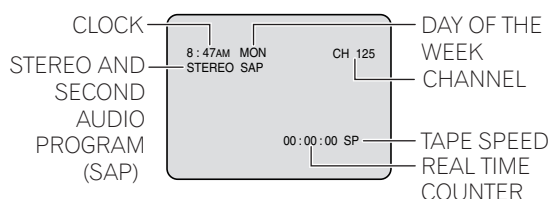

While operating a tape

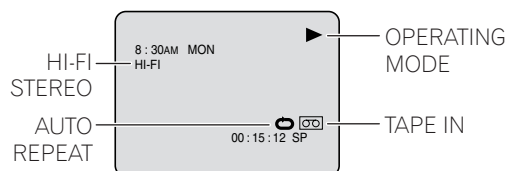

To cancel the display:

Press **DISPLAY** until all indicators disappear.



ZERO RETURN function / Video index search system

VCR

ZERO RETURN function

This function makes tape rewinding stop at the counter "00:00:00" position automatically.

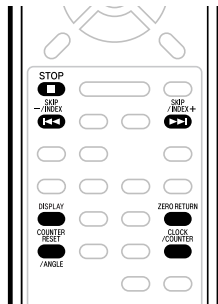

Note

- If you rewind the tape beyond "00:00:00", a minus sign ("-") will be displayed in front of the time.
- When you load a tape, the counter will reset to "00:00:00".
- The counter does not function on nonrecorded (blank) sections of the tape. When you rewind, fast forward or play tapes through blank sections, the counter stops.

1 Press DISPLAY.

The counter display shows the tape running time during playback or recording.

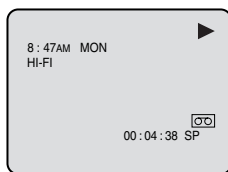

2 Press COUNTER RESET at the desired tape position. The counter display will be reset to the "00:00:00" position (e.g. the beginning of recording).

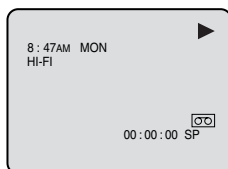

3 Press STOP when playback or recording is finished. Press ZERO RETURN.

The tape will be rewound or fast forwarded and automatically stop at the "00:00:00" position.

Switching the display between clock and counter

Press **CLOCK/COUNTER**. The clock and tape counter alternate with each other in the display.

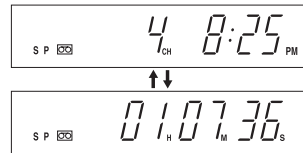

Video index search system

This function enables you to locate the beginning of any recording made on the VCR.

Note

- When you record an INDEX mark at the very beginning of the tape, the mark may not be found.
- During INDEX search, the tape may stop and begin to play at a slightly different location.
- INDEX may not function properly with old or worn out video tapes.
- INDEX marks may not be found if it is extremely close to the point where the search began.
- In recording, if you stop recording temporarily, the INDEX mark is not recorded on the tape.

Recording an INDEX MARK

The Index search function automatically records an INDEX mark on the tape whenever a recording is initiated.

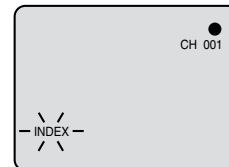

Index search

Press **INDEX** **▶▶▶** or **◀◀◀** during stop or play mode.

For Succeeding programs: Press **INDEX** **▶▶▶**.

For Preceding programs: Press **INDEX** **◀◀◀**.

(Additional press increases the INDEX NO. up to 9.)

When the **INDEX** **▶▶▶** or **◀◀◀** is pressed, the unit starts searching the INDEX NO. selected and finds the portion, then playback starts automatically.

To stop the Index Search, press **STOP**.

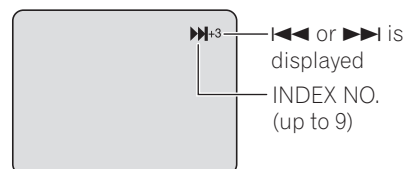



Chapter 6

Recording

Read this before recording on disc

This section explains things you must know to record onto a disc. Read it before attempting to record.

Types of disc

You can use DVD-RW and DVD-R discs to record video.

DVD-RW discs

- Ver 1.1/1.2 discs can be formatted for recording in either of the two modes: the VR mode or the Video mode. Ver.1.0 discs can only be formatted for recording in the VR mode.
- High quality images and sound can be repeatedly recorded about 1,000 times.
- A disc formatted in the VR mode can have as many as 99 original titles and playlist titles each. Discs formatted in the Video mode can have up to 99 original titles.

DVD-R discs

- Discs can only be recorded in the Video mode.
- Discs can be recorded only once.
- Up to 99 titles can be created.

For more information on recording format, see "Recording format" (page 10).



Notes on recording in the Video mode

- The Video mode cannot be selected for Ver. 1.0 DVD-RW discs.
- The remaining available area on the disc decreases as recording progresses. Additional contents can be recorded in the remaining time area, but it cannot be overwritten into the recorded area.
- To format a new DVD-RW in the Video mode, set the automatic format feature to the Video mode. (See page 27.)



Note

- Should a power failure occur or should the AC cord plug be disconnected while recording, editing, initializing, finalizing or any other function, the program being recorded will be lost or the disc may not be playable. Manufacturer cannot guarantee against loss of program or disc should this occur.

Recording modes

There are 4 modes for recording on disc. Recording time and quality vary according to mode.

Recording mode	Recording time	Quality
XP	Approx. 60 min	Can record high quality images.
SP	Approx. 120 min	Can record normal quality images.
LP	Approx. 240 min	Quality deteriorates slightly, but recording time is longer.
EP	Approx. 360 min	Recording time is prioritized over quality.

- Recording time above is based on a 4.7GB disc.

Please note that there is a trade-off between recording time and quality. The longer the possible recording time, the lower the recorded picture quality. You may wish to try recording different kinds of program in different modes to determine the combination of picture quality and recording time that suits your needs.

We recommend that the **XP** mode be used for recording fast moving or action programs.

Since DVD recording is performed using VBR (Variable Bit Rate), recording time varies according to the recorded content.

To know the correct recording time, stop recording and check the media information. (See page 35.)



Note

- Recording time can change for the following reasons.
 - When image quality is poor as during poor TV reception.
 - When recording on a disc that has been edited before.
 - When the video is followed with recordings of still images or just audio.



Disc remaining time

VR mode

- Recording is possible as long as there is available space on the disc. (Finalized discs can be recorded by cancelling the finalization, see "UNDO FINALIZE" on page 28.)
- Erasing unnecessary title frees up available space on the disc. (Titles can be erased from finalized discs by first undoing the finalization. See "UNDO FINALIZE" on page 28.)

Video mode

- Up until the disc is finalized, recording is possible as long as there is available space on the disc. (Once the disc has been finalized, additional recording and erasing are not possible.)
- The remaining time cannot be increased, nor can recorded title be overwritten.
- Titles cannot be erased nor can recorded titles be overwritten.



Note

- When using one touch timer recording to record on a DVD disc, it takes some time from when you press **REC** until recording actually starts. Press **REC** a little before your preferred starting point.
- Even if **STOP** is pressed during recording, recording does not stop instantly. It takes a maximum of 1 minute for the information needed for the disc to be compiled after pressing **STOP**.
- Because of characteristics peculiar to digital video compression technology, scenes with fast motion may appear as a matrix of larger blocks.

Images that cannot be recorded

Some DVD-Video and broadcasts contain copy-restriction signals to protect copyrights. There are 3 types of copy-restriction signals: "Copy Free", "Copy Never" and "Copy Once".

"Copy Free" (unrestricted recording)

Land-based TV broadcasts and images you record yourself with a video camera allow unrestricted recording. There are no restrictions on recording.

"Copy Never" (recording prohibited)

- Images that contain the recording prohibited signal cannot be recorded.
- If the recording prohibited signal appears halfway through an image you are recording, recording is paused at that instant. When the recording prohibited signal ends, recording resumes.
- This unit incorporates a built-in copy guard. It cannot record software or broadcasted programs that contain copy restriction signals designed to protect copyright, etc.

"Copy Once" (one-time recordable)

Programs (images) that contain the one-time recordable signal can be recorded only in the VR mode using a DVD-RW disc that supports CPRM Ver. 1.1 and Ver. 1.2.



Recording a TV program

VR mode **Video mode** **DVD-R** **VCR**

You can record programs you watch on TV onto video tapes or DVDs.

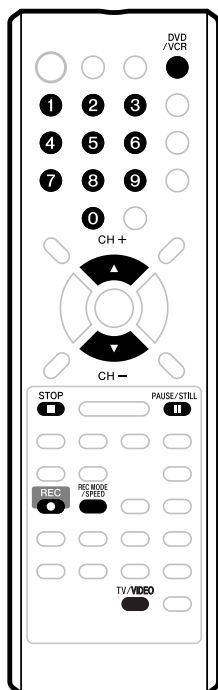

Preparation:

- Turn ON the TV and set it to the video input mode.
- Load a recordable DVD or video tape into the unit.
- Press **DVD/VCR** to select the appropriate mode.

1 Press REC MODE/SPEED to select the recording mode.

The recording mode will appear on the TV monitor and change every time **REC MODE/SPEED** is pressed.

VCR recording modes: SP/EP

DVD recording modes: XP/SP/LP/EP

SP is the normal recording mode for video tapes. EP offers 3 times the recording time as SP. For more information on DVD recording modes, see page 52.

2 Set the TV/CABLE option to the appropriate position (page 32).

TV - VHF/UHF channels
CABLE - CABLE TV channels

3 Press the numeric keys or CH +/- to select the channel to be recorded.

- 1-9 Press **0** twice and then **1-9** as required.
Example: To select 2, Press "**002**".
- 10-12 Press **0** first and then the remaining 2 digits in order from left to right.
Example: Press **012** for "12".
- 13-99 Press 2 digits in order.
Example: Press **22** for "22".
- 100-125 Press the 3 digits in order.
Example: Press **110** for "110".

VHF/UHF/CABLE CHANNELS

TV	CABLE
VHF 2-13	VHF 2-13
UHF 14-69	STD/HRC/IRC 14-36 (A) (W) 37-59 (AA) (WW) 60-85 (AAA) (ZZZ) 86-94 (86) (94) 95-99 (A-5) (A-1) 100-125 (100)(125) 01 (5A)



4 Press REC.

When recording starts, "●" appears on the screen for about 4 seconds.



Note

- When recording onto a DVD, it takes some time from when you press **REC** until recording actually starts.
Press **REC** a little before your preferred starting point.
With a video tape, recording starts almost at the same time you press **REC**.
- If the erase prevention tab of video tapes is removed, the tape will eject when **REC** is pressed for recording.

Auto Rewind feature

This VCR will automatically rewind the tape when the tape has ended (except during OTR and TIMER REC). It will also eject the tape.



Note

- If the disc space become full, the recording is stopped and "RECORDING INTERRUPTED" will appear on the screen.

To stop recording

Press **STOP** to stop recording.

"■" will appear on the screen for about 4 seconds.



Note

- When recording onto a DVD, even if **STOP** is pressed during recording, recording does not stop instantly. It takes a maximum of 1 minute for the information needed for the disc to be compiled after pressing **STOP**.

To stop recording temporarily

Press **PAUSE/STILL** to avoid recording unwanted material.

"●||" will appear on screen for about 4 seconds.

Press again to resume recording.



Note

- In video recording, the pause function will be released after 5 minutes to prevent damage the video tape. The unit will change to the STOP mode.
- When recording onto a video tape, you can select a recording channel in the recording pause mode (You cannot change a recording channel in the DVD recording pause mode.)
- Chapter marks are made when recording to a DVD in the VR Mode.

Recording one program while watching another

While the unit is recording, press **TV/VIDEO** to select the TV position.

The "TV" will go on and recording will continue.

Select the TV channel you want to watch by using the TV channel selector.



Note

- Some CATV hookups do not permit viewing one channel while recording another. See pages 18, 19.

One-touch Timer Recording (OTR)

VR mode **Video mode** **DVD-R** **VCR**

The One-touch Timer Recording feature provides a simple and convenient way to make a timed recording.

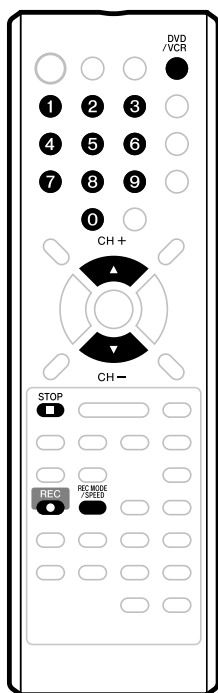

Note

- If you wish to watch the DVD playback during the VCR OTR, press **DVD/VCR** to change to DVD mode and perform the DVD playback. You can also playback the VCR during DVD OTR.

Preparation:

- Turn ON the TV and set to the video input mode.
- Load a recordable DVD or video tape into the unit.
- Press **DVD/VCR** to select the appropriate mode.

Example:

One-touch Timer Recording for 30 minutes.

1 Press REC MODE/SPEED to select the recording mode.

For the recording mode, see the step 1 on page 54.

2 Set the TV/CABLE option to the appropriate position (See page 32).

TV - VHF/UHF channels
CABLE - CABLE TV channels

3 Press numeric keys or CH +/- to select the channel to be recorded.

4 Press REC. Each additional press of REC will increase recording time as shown in the chart below, up to a maximum of 6 hours. The OTR and recording time will appear on the screen for about 4 seconds.

Press	Recording time	Press	Recording time
once	NORMAL REC	7 times	OTR 3:00
twice	OTR - : - -	8 times	OTR 4:00
3 times	OTR 0:30	9 times	OTR 5:00
4 times	OTR 1:00	10 times	OTR 6:00
5 times	OTR 1:30	11 times	NORMAL REC
6 times	OTR 2:00		

To cancel OTR

Press **STOP** or turn off the power.

"■" will appear on screen for about 4 seconds.



VCR Plus+® programming system

VR mode Video mode DVD-R VCR

What is the VCR Plus+ programming system?

VCR Plus+ system is a timer programming system which simplifies timer recording programming. Instead of entering the date, channel and recording time, you simply enter a PlusCode® programming number that you can find in your TV listings.

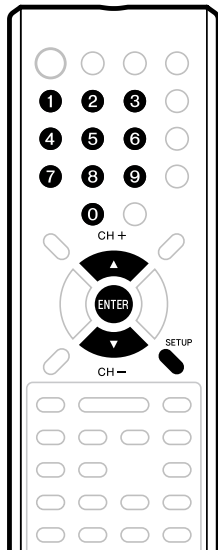

2 Press ▲ or ▼ to select "GUIDE CH SET" and press ENTER.

A window appears to set a guide channel number and the corresponding tuner channel number.

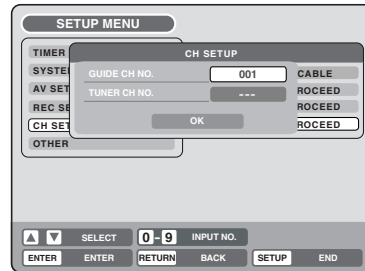

3 Enter a GUIDE CH NO. (guide channel number).

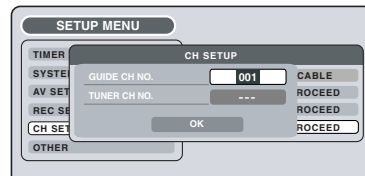

There are two ways to do this:

- To select numbers you can either use the number buttons and then ENTER, or you can press ENTER first then use the ▲/▼ buttons to select a number, followed by ENTER.
- When using the number buttons, enter using three digits—use leading zeros for numbers less than 100.

4 Press ▼ to highlight TUNER CH. NO., then enter the corresponding tuner channel number.

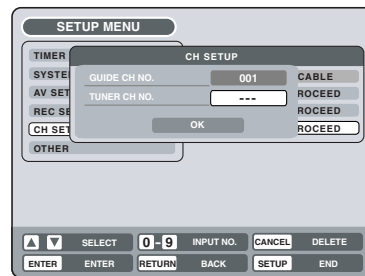

Checking the channel setup to use the VCR Plus+ system

Before you can use the VCR Plus+ system you need to set up the channel mapping. This ensures that the VCR Plus+ system uses the correct channels for recording by matching up the preset channels in the recorder with 'guide channels'. You can find these guide channel numbers in your local TV guide or newspaper TV listings.

1 Press SETUP and press ▲ or ▼ to select "CH SETUP" and press ENTER.

The Channel Setup menu will appear.

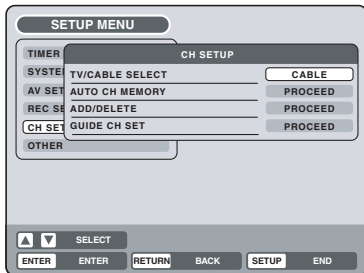

- Select a tuner channel number in the same way as you selected the guide channel number.
- You can also select one of the LINE inputs (LINE 1 or LINE 2) instead of a channel number if some channels are received via an external receiver.

5 Repeat steps 3 – 4 to input the rest of the channel list.

6 Press ▼ to highlight OK and press ENTER.

7 When you're done, press SETUP to exit.



Setting the timer program using the VCR Plus+ system

The VCR Plus+ system simplifies timer recording so that you just enter a PlusCode number (which you can find in your TV listings guide) for the program you want to record, tell the recorder whether you want to record it just once or regularly, and then select the DVD or the VCR for recording.

Note that for the VCR Plus+ system to work correctly, the clock must be set to the right time and the guide channels must be setup (see *Checking the channel setup to use the VCR Plus+ system* above).

1 Press VCR Plus+.

If a PROGRAM FULL message appears then you'll need to delete one of the existing timer programs before continuing. Select a timer program from the list and press **CANCEL**.

2 Use the number buttons to enter the PlusCode number.

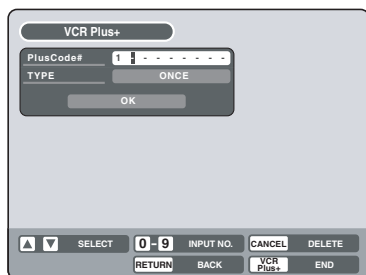

3 Press ▼ to select "TYPE".

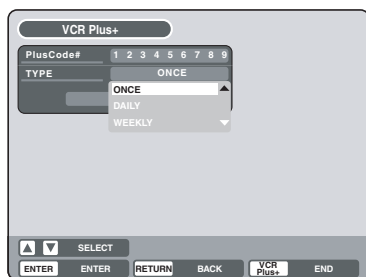

Here you can set whether you want to record the program ONCE, DAILY or WEEKLY. If you want to change it, press **ENTER** then use the ▲/▼ buttons to select, then press **ENTER** again.

4 Press ▼ to highlight OK, then press ENTER.

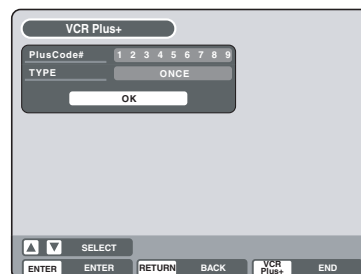

If you've entered a valid PlusCode number, a summary of the timer recording appears. You can edit any of this information as necessary. Use the ▲/▼ buttons to select the item you want to edit, press **ENTER**, then use the ◀/▶ or ▲/▼ buttons as appropriate to select, then press **ENTER** again.

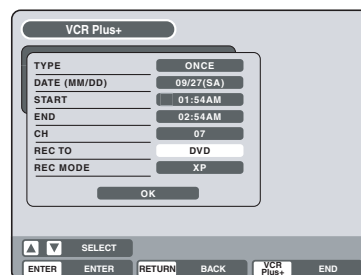

- TYPE – select the frequency of the recording (more options available here than in the previous screen, such as every weekday)
- DATE (MM/DD) – the recording date
- START – recording start time
- END – recording end time
- CH – the channel to be recorded, or one of the external inputs (L1 or L2)
- REC TO – record to the DVD or the VCR
- REC MODE – recording quality
- Note that If you haven't set a guide channel for the selected TV channel, the CH field will be blank (—). In this case, set the channel number manually.

5 Highlight OK and press ENTER.

The TIMER REC SET screen appears and you should see the new timer recording in the list.

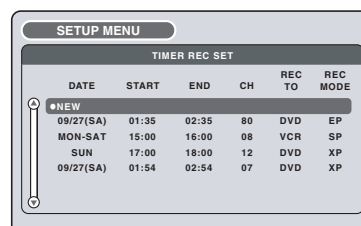

6 Press SETUP to exit.



7 Press TIMER REC. The timer indicator “ [] ” will appear on the display and the unit stands by for recording.

- If the program is DVD recording only, the unit will change to VCR mode automatically. (The DVD mode cannot be selected.)
- If the program is VCR recording only, the unit will change to DVD mode automatically. (The VCR mode cannot be selected.)
- If the programs are DVD and VCR recording, the unit will turn off. If you want to use the unit, press **TIMER REC** again to deactivate the timer.

To extend the timer recording time

Press **TIMER REC** while it is timer recording. (You may also use normal recording or OTR.)

Note

- If you press **STANDBY/ON** and it goes into the STANDBY mode, if you then press **TIMER REC**, the timer recording will end.

Checking or changing the timer recording

When you want to check the selected timer recording, follow the steps **1** and **2** of “Setting timer recording” and display the TIMER REC SET screen.

To change the timer recording, select the program to be changed and press **ENTER**. The changing method is the same as that for the recording a program for the first time.

Cancelling the timer recording

Display the TIMER REC SET screen. Select the program you want to cancel and press **CANCEL**, then the selected program will be erased from the timer recording list.

In case timer programs-overlap

Do not overlap timer programs as portions of the conflicting programs will be lost. The first recording time has priority over the next recording time as shown in the diagram below.

In this case, the next recording time is delayed a maximum of about 1 minute.

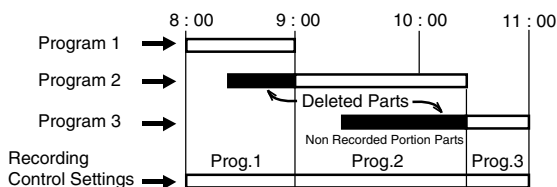

Note

- Recording starts a few seconds before the preset starting time.
- You cannot use the timer recording for the both DVD and VCR at the same time.
- You can playback the DVD during the VCR timer recording, and you can playback the VCR during the DVD timer recording.

- If a recordable tape is not inserted or no disc space is available, the timer record indicator “ [] ” flashes, and “TIMER RECORDING ERROR. PLEASE CHECK THE DISC OR TAPE.” appears on the screen. Replace the tape or disc to allow recording.
- If you perform any operation during timer recording, the power will not go OFF when timer recording finishes. To turn the power OFF, press **STANDBY/ON**.
- From about 2 minutes before timer recording starts, some operations cannot be done.
- If you set recording to start less than 2 minutes ahead of time, the power will not turn OFF after recording finishes.
- If the recording media fills up during timer recording, “ [] ” will flash and the power will not turn OFF. Also, any timer recording scheduled for later is cancelled.
- When the PROGRESSIVE indicator “ P ” appears in the display window (progressive scanning mode) and the VCR mode is selected, you cannot display the PlusCode input screen. Switch to the DVD mode when entering PlusCode.

Timer recording

VR mode **Video mode** **DVD-R** **VCR**

The timer recording system allows you to select the date, time and channel and record the desired programs. Up to 12 timer programs within a month can be stored in this unit.

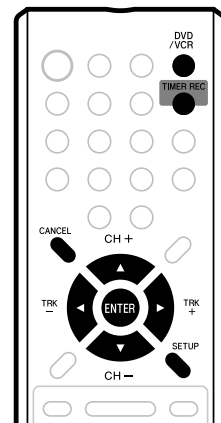

Setting timer recording

Preparation:

- Turn ON the TV and set to the video input mode.
- Load a recordable DVD or video tape.
- Press **DVD/VCR** to select the appropriate mode.
- Confirm that the clock is indicating the correct time.

Example:

Set the recording mode to LP; the TV program is on channel 12 starting at 8:00 PM and stopping at 9:30 PM on a date of 20th.



1 Press SETUP.

The SETUP MENU screen will appear.

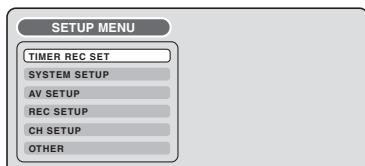
**2 Press ▲ or ▼ to select "TIMER REC SET" and press ENTER.**

The TIMER REC SET screen will appear.

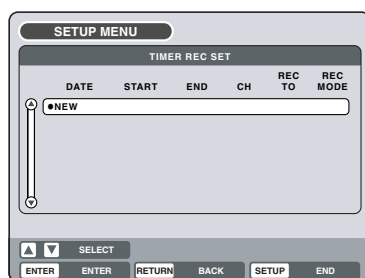
**3 Press ▲ or ▼ to select "NEW" and press ENTER.**

The program screen will appear.

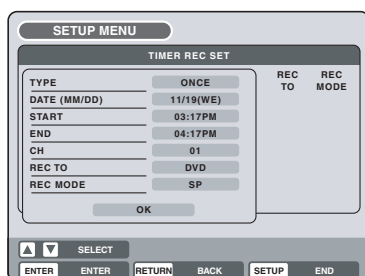
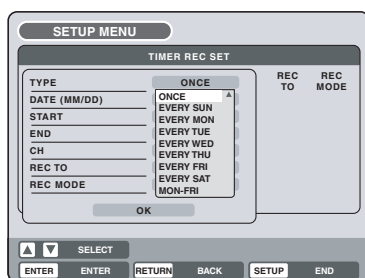
**4 Press ▲ or ▼ to select "TYPE" and press ENTER. Press ▲ or ▼ to select "ONCE" from the list and press ENTER.****Note**

- If you select timer recording on a specified date only one time, select "ONCE" in the "TYPE" for recording. You can record same days of every week or from Monday to Friday using the item "TYPE". The items you can select are as follows:

ONCE: Recording on the selected "DATE"

EVERY SUN: Recording every Sun.

EVERY MON: Recording every Mon.

EVERY TUE: Recording every Tue.

EVERY WED: Recording every Wed.

EVERY THU: Recording every Thu.

EVERY FRI: Recording every Fri.

EVERY SAT: Recording every Sat.

MON-FRI: Recording from Mon. to Fri.

MON-SAT: Recording from Mon. to Sat.

EVERYDAY: Recording everyday.

5 Press ▲ or ▼ to select "DATE" and press ENTER. Press ▲ or ▼ to select the date to be recorded from the list and press ENTER.**6 Press ▲ or ▼ to select "START" and press ENTER.**

Set the time when the recording is started.

- To switch over the selection item (hour or minute), press ◀ or ▶, then press **ENTER**.
- Press ▲ or ▼ to adjust the time.
- After setting the time, press **ENTER**.

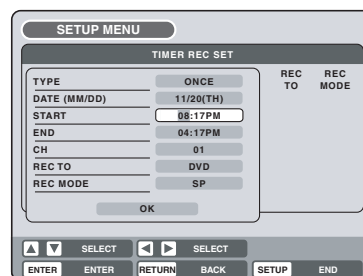

- The starting and stopping times for the recording are displayed on the 12-hour (am/pm) clock. Twelve o'clock midnight is displayed as "12:00AM", whereas twelve o'clock noon is displayed as "12:00PM".

7 Press ▲ or ▼ to select "END" and press ENTER.

Set the stopping time in the same manner for setting the starting time of timer recording.

8 Press ▲ or ▼ to select "CH" and press ENTER.

- Press ▲ or ▼ to select the channel to be recorded.
- You can select the external input (L1 or L2) by pressing ◀ or ▶.

9 Press ▲ or ▼ to select "REC TO" and press ENTER.

Select the media (DVD or VCR) to be recorded from the list and press **ENTER**.

- The initial setting of "REC TO" and "REC MODE" can be changed using "Setting the recording". (See page 31.)



10 Press ▲ or ▼ to select "REC MODE" and press ENTER.

The recording modes for the media selected in "REC TO" item are listed.

Select the recording mode and press **ENTER**.

For the recording modes in VCR, see page 48, and for the recording modes in DVD, see page 52.

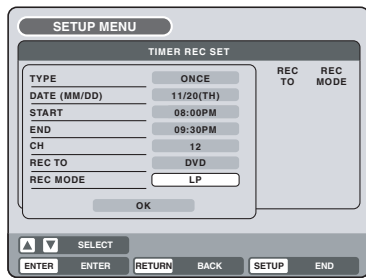

11 Select "OK" and press ENTER.

The timer program is determined and the TIMER REC SET screen appears again.

12 When you enter the other program for the timer recording, repeat the steps 3 to 11.

13 Press SETUP.

The TIMER REC SET screen disappears and the display will return to the normal screen.

14 Press TIMER REC. The timer indicator "⏸" will appear on the display and the unit stands by for recording.

- If the program is DVD recording only, the unit will change to VCR mode automatically. (The DVD mode cannot be selected.)
- If the program is VCR recording only, the unit will change to DVD mode automatically. (The VCR mode cannot be selected.)
- If the programs are DVD and VCR recording, the unit will turn off. If you want to use the unit, press **TIMER REC** again to deactivate the timer.

To extend the timer recording time

Press **TIMER REC** while it is timer recording. (You may also use normal recording or OTR).

Note

- If you press **STANDBY/ON** and it goes into the **STANDBY** mode, if you then press **TIMER REC**, the timer recording will end.

Checking or changing the timer recording

When you want to check the selected timer recording, follow the steps 1 and 2 of "Setting timer recording" and display the TIMER REC SET screen.

To change the timer recording, select the program to be changed and press **ENTER**. The changing method is the same as that for the recording a program for the first time.

Cancelling the timer recording

Display the TIMER REC SET screen.

Select the program you want to cancel and press **CANCEL**, then the selected program will be erased from the timer recording list.

In case timer programs-overlap

Do not overlap timer programs as portions of the conflicting programs will be lost. The first recording time has priority over the next recording time as shown in the diagram below.

In this case, the next recording time is delayed a maximum of about 1 minute.

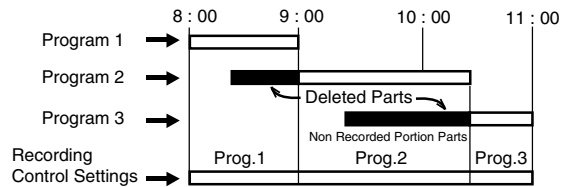

Note

- Recording starts a few seconds before the preset starting time.
- You cannot use the timer recording for the both DVD and VCR at the same time.
- You can playback the DVD during the VCR timer recording, and you can playback the VCR during the DVD timer recording.
- If a recordable tape is not inserted or no disc space is available, the timer record indicator "⏸" flashes, and "TIMER RECORDING ERROR. PLEASE CHECK THE DISC OR TAPE." appears on the screen. Replace the tape or disc to allow recording.
- If you perform any operation during timer recording, the power will not go OFF when timer recording finishes. To turn the power OFF, press **STANDBY/ON**.
- From about 2 minutes before timer recording starts, some operations cannot be done.
- If you set recording to start less than 2 minutes ahead of time, the power will not turn OFF after recording finishes.
- If the recording media fills up during timer recording, "⏸" will flash and the power will not turn OFF. Also, any timer recording scheduled for later is cancelled.

Stereo recording and playback

The VHS Hi-Fi audio system permits high fidelity recording of MTS STEREO TV broadcasts.

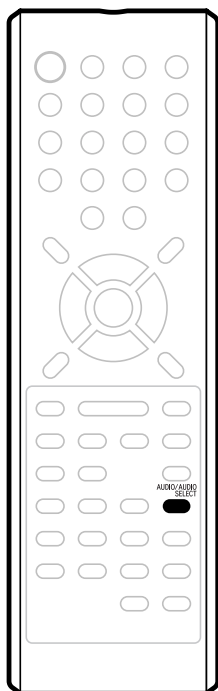

Note

- When playing back a video tape or disc that is not recorded in Hi-Fi stereo mode, the audio will automatically be monaural.
- When listening to a Hi-Fi video tape, disc or MTS broadcast through the RF OUT (UHF/VHF) jack (Audio/Video cord not connected), the sound will be monaural.

When a MTS STEREO broadcast is received, the word "STEREO" will appear on the screen and the program can be viewed or recorded in stereo.

The Hi-Fi STEREO recording procedure is the same as for normal recordings.

Note

- When using a Cable TV system, stereo TV programs may be transmitted over a mono Cable TV channel. In this case the word "STEREO" will not appear and the sound will be in mono.

Output selection for VCR **VCR**

When viewing an MTS STEREO TV program, or playing a prerecorded Hi-Fi STEREO on video tape, press **AUDIO SELECT** to select how the audio will be heard through the speakers. Normally set to the Hi-Fi STEREO position, this button can be set to the MONO position if the stereo audio is of poor quality. The "R" and "L" positions allow the audio from the Right or Left Hi-Fi channel to be heard over both TV speakers. This button has no effect when viewing a monaural audio program. Each time when you press the button, output selection display appears on the screen for several seconds. Refer to the chart below.

OUTPUT SELECTION	SOUND HEARD ON BOTH SPEAKERS
STEREO	STEREO
L ch	LEFT CHANNEL AUDIO
R ch	RIGHT CHANNEL AUDIO
MONO	MONO

Output selection for DVD **VR mode** **Video mode** **DVD-R**

You can switch between the left or right channel and stereo only when playing a disc on which a bilingual broadcast was recorded in the DVD-RW VR mode. It is not possible to switch between channels otherwise as only the channel selected in the setting of SAP (Second Audio Program; ON or OFF) is recorded in the DVD-RW Video mode or DVD-R (see page 31).

Note

- When a stereo or monaural broadcast is recorded, either stereo or monaural, respectively, is played back and it is not possible to switch between channels.



Chapter 7 Editing

Editing the disc

This section explains how to edit the recorded contents on DVD-RWs. However, the items that you can edit vary with the recording formats. In VR mode, you can edit various title menus, whereas in Video mode, you can edit only a few items.

Title menu

When the content is recorded, a title name that includes the date, time, channel number and other information is created automatically.

The title menu can be used when you playback after confirming the contents (see page 34), or when you check the contents recorded on the disc.

Original title

The titles explained above are called original titles; these will be added with every recording. In VR mode you can do various editing operations – renaming titles, adding chapter marks, etc. In addition, you can erase the unnecessary titles to increase the disc space.

Playlist

You can create a playlist based on the original titles. You can combine or erase undesired scenes. If you create a playlist it will become the primary list used by the disc.

If you create a playlist to customize your viewing preferences, and choose to delete it, the original titles will not be affected. It is recommended to create and edit the playlist to prevent important titles from being erased accidentally.

If you create a playlist, both the original title and playlist will be displayed on the title menu.

Editable items

The items that can be edited are different between original title and playlist. For the disc in Video mode, only the title name can be edited.

The items can be edited in each are as follows:

Editing items	VR mode		Video mode
	Original	Playlist	Original
Playback	Y	Y	Y
Adding chapter mark	Y	N	N
Combining chapters	Y	N	N
Erasing scenes	Y	Y	N
Erasing titles	Y	Y	N
Renaming titles	Y	Y	Y
Creating playlist	Y	N	N
Combining titles	N	Y	N

If you finalize the disc in Video mode, the title list will be created and you cannot use the title menu.

Note

- This unit cannot record or edit a disc which was recorded or edited using another DVD recorder.
- You cannot edit or record the disc on which disc protection is set. In such a case, be sure to cancel the disc protection (see page 28) before starting the operation.
- When a scene has been erased, the selected position for erasing may vary slightly from the actual erased position.



Editing a playlist

VR mode

You can create and edit the playlist based on the original title.

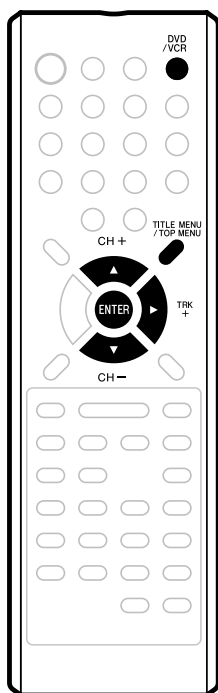

Note

- A playlist can only be created with a DVD-RW in VR mode. You cannot create a playlist with a DVD-RW in Video mode, nor with a DVD-R.
- In case the disc includes more than 10 titles, you can turn to the next or the previous page. (See page 34.)
- You cannot switch to the VCR mode when the title menu is showing. Press **TITLE MENU** to clear the title menu, then press **DVD/VCR** to switch to the VCR mode.

Preparation:

- Turn ON the TV and set to the video input mode.
- Load the recorded DVD-RW (VR).
- Press **DVD/VCR** to select the DVD mode. (The DVD indicator will light.)

Creating a playlist

VR mode

- 1 Press **TITLE MENU**.
The title menu will appear.

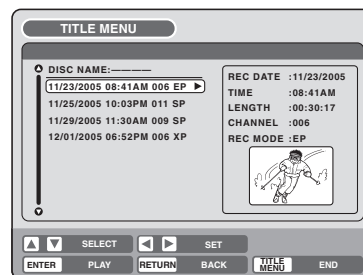

- 2 Press **▲** or **▼** to select the original title which will be used as the base of a playlist.

- 3 Press **▶**.
The editing menu of original title will appear.

- 4 Press **▲** or **▼** to select "NEW PLAYLIST".



- 5 Press **ENTER**.
The editing menu closes and the created playlist appears at the bottom of the list.

Created playlist

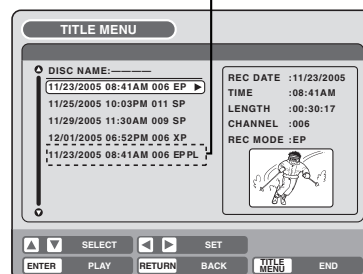



Changing a title name

VR mode

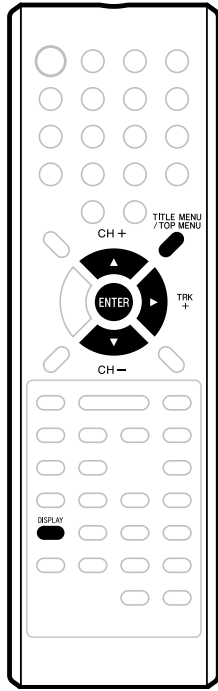

- 1 Press **TITLE MENU** to display the title menu.
- 2 Select the playlist where you want to change the title name.
 - Press **▲** or **▼** to select the playlist.
 - Press **▶** to display the editing menu of the playlist.
 - Press **▲** or **▼** to select "RENAME TITLE".

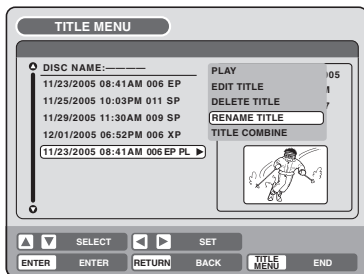

3 Press **ENTER**.

The keyboard screen will appear.

4 Use the keyboard screen to enter the title name.

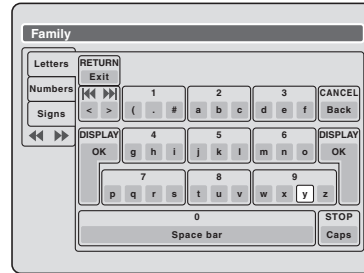

5 Press **DISPLAY** to return to the title menu.

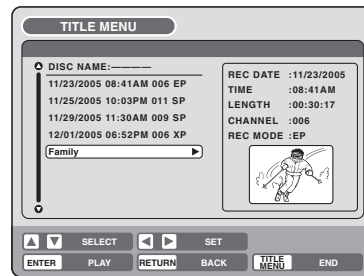

Note

- The title name can be a maximum of 64 characters. Long names will be shortened in the title menu.
- For using the keyboard screen, see "Using the keyboard screen" (page 76).



Erasing a scene (Edit title)

VR mode

You can erase an unnecessary scene from the created playlist. When you erase the scene from the playlist, the scene is not erased from the original title.

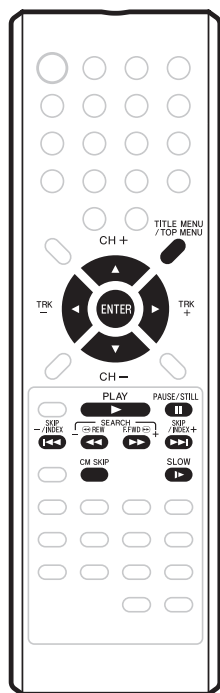

1 Press **TITLE MENU** to display the title menu.

2 Select the playlist where a scene you want to erase is included.

- Press **▲** or **▼** to select the playlist.
- Press **▶** to display the editing menu of the playlist.
- Press **▲** or **▼** to select "EDIT TITLE".

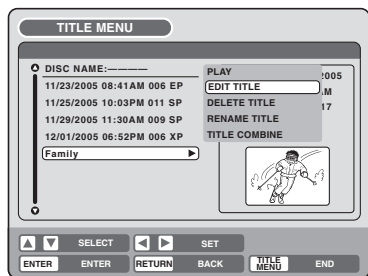

3 Press **ENTER**.

The EDIT TITLE screen appears.

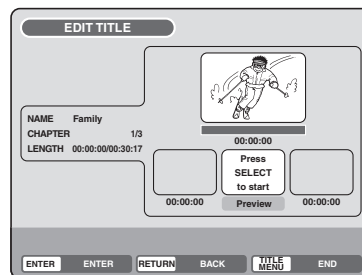

4 Press **ENTER** to playback the playlist on the EDIT TITLE screen.

Use each operation button (**F.FWD**, **REW**, **SKIP +**, **SKIP -**, **PLAY**, **PAUSE/STILL**, **SLOW**, **CM SKIP**) for the playback to search the starting point of the scene you want to erase.

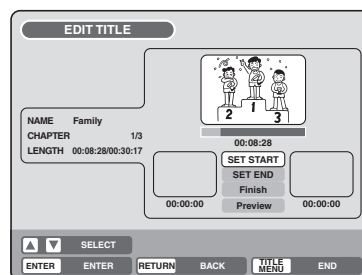

5 Press **▲** or **▼** to select "SET START" at the start point of the scene that you want to erase and press **ENTER**. (To set the start point easily, search the start point while "SET START" is selected)

The still image at the start point appears at the left small screen.

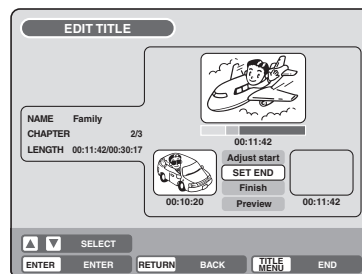



6 Press ▲ or ▼ to select "SET END" at the end point of the scene you want to erase and press ENTER.

The still image at the end point appears at the right small screen.

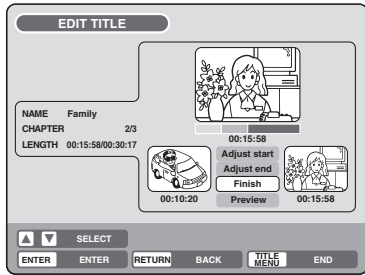

7 Check the erased scenes.

- Select "Preview" and press **ENTER**. Then the video where the scenes between the start and end points are erased is played back.
- Each operation button (**F.FWD**, **REW**, **SKIP +**, **SKIP -**, **PLAY**, **PAUSE/STILL**) for playback also can be used.

8 Adjust the start and end points.

- To adjust the start point, select "Adjust start" and press **ENTER**. You can change the start point by pressing ◀ or ▶.
- To adjust the end point, select "Adjust end" and press **ENTER**. You can change the end point in the same way as the start point.

9 If you determine the scene to be erased, press ▲ or ▼ to select "Finish" and press ENTER.

- A chapter mark is automatically added at the location of the erased scene.



Note

- It is no problem to omit the procedures for confirming the scene or adjusting start and end points.
- It is not possible to make any adjustments for 2 seconds after a title starts or 2 seconds before it ends.
- To set a start point at the beginning of a title, set it during countdown.
- The points during editing may be different from the preview.
- Start and end points are adjusted in units of 1 second.



Combining the title

VR mode

You can create a playlist by combining the several original titles or playlists.
To combine the titles, it is necessary to create a playlist at first. By combining the titles in the playlist, a playlist where several titles are combined is created.

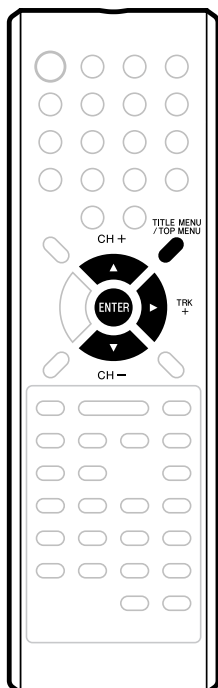

3 Press ENTER.

Select the title that you want to combine from the title menu.

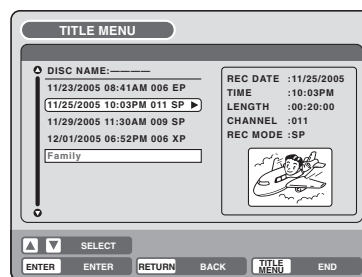

4 Press ENTER.

Following the playlist, the selected title is combined. The several titles were combined so that the total recording time is displayed.

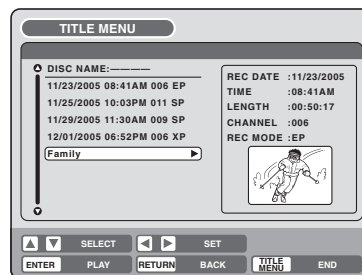

1 Press TITLE MENU to display the title menu.

2 Select the playlist where you want to combine the titles.

- Press ▲ or ▼ to select the playlist.
- Press ► to display the editing menu of the playlist.
- Press ▲ or ▼ to select "TITLE COMBINE".

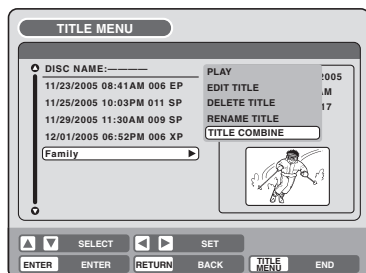



Erasing a playlist

VR mode

You can erase the created playlist. Even if you erase the playlist, the original title will not be erased.

3 Press ENTER.

The selected playlist will be erased.

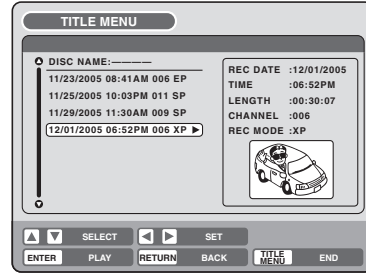
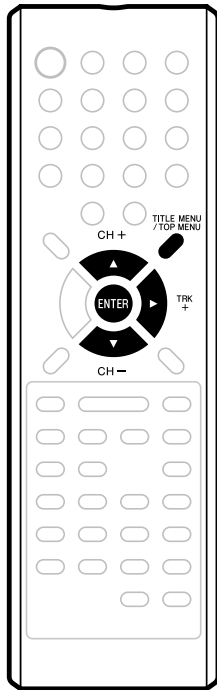

1 Press TITLE MENU to display the title menu.

2 Select the playlist that you want to erase.

- Press ▲ or ▼ to select the playlist.
- Press ► to display the editing menu of the playlist.
- Press ▲ or ▼ to select "DELETE TITLE".

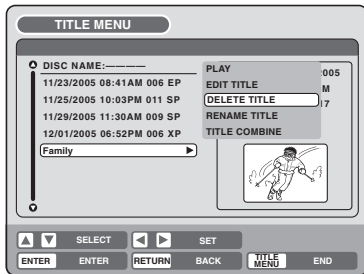

Editing an original title

VR mode

In VR mode, you can edit various items, whereas in Video mode, you can edit the title names only.

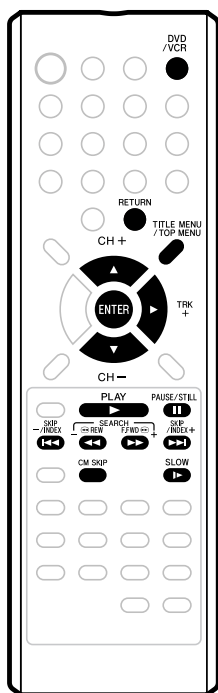

Note

- You can automatically add a chapter mark in recording. For more information, see page 31.
- In case the disc includes more than 10 titles, you can turn to the next or the previous page. (See page 34.)

Preparation:

- Turn ON the TV and set to the video input mode.
- Load the recorded disc.
- Press **DVD/VCR** to select the DVD mode. (The DVD indicator will light.)

Adding a chapter mark

VR mode

You can add a chapter mark to the original title. You can add up to 999 chapter marks to one disc, and up to 99 chapter marks to one title.

- Press **TITLE MENU** to display the title menu.
- Select the original title where a chapter mark is added.
 - Press **▲** or **▼** to select the original title.
 - Press **▶** to display the editing menu of the original title.
 - Press **▲** or **▼** to select "ADD CHAPTER MARK".



- Press **ENTER**.

The ADD CHAPTER MARK screen will appear.

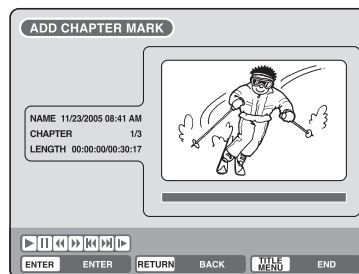

- Press **PLAY** to search a scene where you want to add the chapter mark.

- Search the scene by using each operation button (**F.FWD**, **REW**, **SKIP +**, **SKIP -**, **PAUSE/STILL**, **SLOW**, **CM SKIP**) for the playback.

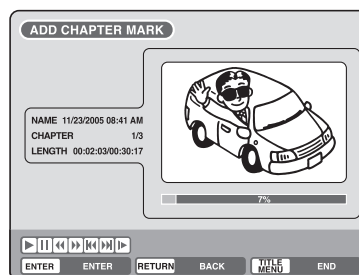



5 At the point in the scene you want to add the chapter mark, press ENTER.

The playback is paused and the position of the added chapter mark appears green.

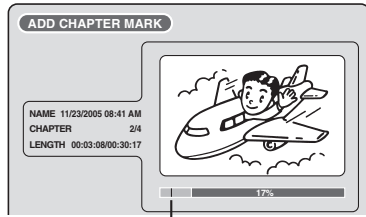

The added chapter mark

6 If you want to continue to add chapter marks, repeat step 5.

- To display the title menu, press **RETURN**.
- To return to the normal screen, press **TITLE MENU**.





Combining chapters

VR mode

By erasing the added chapter marks, the chapters can be combined.

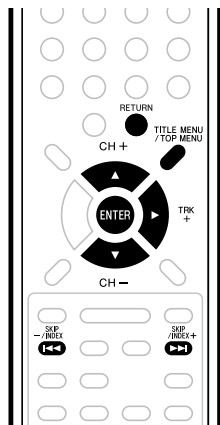

- 1 Press **TITLE MENU** to display the title menu.
- 2 Select the original titles where you want to combine the chapters.
 - Press **▲** or **▼** to select the original title.
 - Press **▶** to display the editing menu of original title.
 - Press **▲** or **▼** to select "COMBINE CHAPTERS".

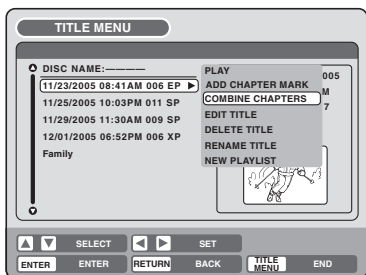

- 3 Press **ENTER**.
The COMBINE CHAPTERS screen will appear. At the beginning, the top still image in the chapter 2 is displayed.

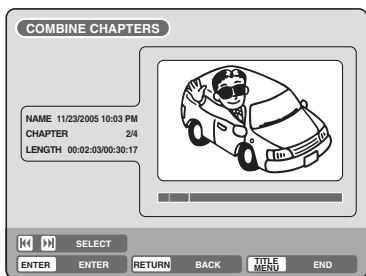

- 4 Press **SKIP +** or **SKIP -** to select the chapter marks to be erased.

- 5 Press **ENTER**.
The chapter marks are erased and 2 chapters are combined into 1 chapter.

- 6 To continue erasing chapter marks, repeat steps 4 and 5.

- To display the title menu, press **RETURN**.
- To return to the normal screen, press **TITLE MENU**.

Note

- Chapter marks that have been added automatically in the erasing of a scene procedure (page 73) cannot be erased.

Changing an original title name

VR mode Video mode DVD-R

You can only add title names to DVD-R and Video mode discs before they have been finalized.

- 1 Press **TITLE MENU** to display the title menu.
- 2 Select the original title that you want to rename.
 - Press **▲** or **▼** to select the original title.
 - Press **▶** to display the editing menu of original title.
 - Press **▲** or **▼** to select "RENAME TITLE".



- 3 Press **ENTER**.
The keyboard screen will appear.
The entering method of the title name is the same as for the playlist. See the steps 4 and 5 of "Changing a title name" in "Editing a playlist" (page 65) and enter the title name.

Note

- The title name can be a maximum of 64 characters in VR mode and a maximum of 30 characters in Video mode.
Long names will be shortened in the title menu.
- "RENAME TITLE" can only be used with DVD-R discs and video mode DVD-RW discs before they have been finalized.





Erasing a scene (Edit title)

VR mode

You can erase an unnecessary scene from the original title.

Erase the scene after checking the title. You cannot restore the erased scene.

When you erase the scene, you can increase the disc space.

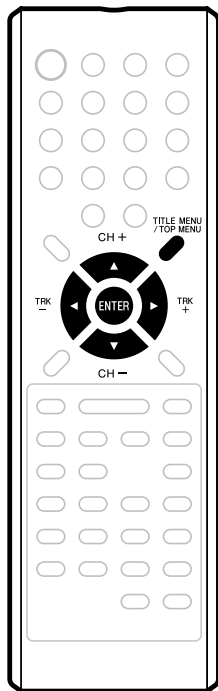

- 1 Press **TITLE MENU** to display the title menu.
- 2 Select the original title where a scene you want to erase is included.

- Press **▲** or **▼** to select the original title.
- Press **▶** to display the editing menu of original title.
- Press **▲** or **▼** to select "EDIT TITLE".

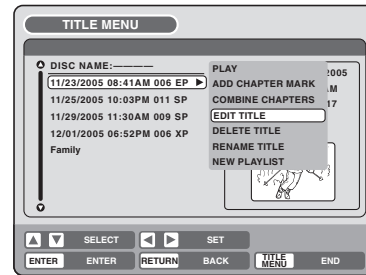

- 3 By pressing **ENTER**, the following message screen will appear.



- 4 Press **◀** or **▶** to select "YES" and press **ENTER**, then the **EDIT TITLE** screen will appear.
 - By selecting "NO", the title menu appears.
- 5 The method for erasing a scene is the same as for the playlist. See the steps 4 to 9 of "Erasing scenes (Edit title)" in "Editing a playlist" (page 66).

Note

- If the scene is erased from the original title, the created playlist is erased.
- Disc space will only be freed up if scenes lasting several minutes are deleted.
- A chapter mark is automatically added at the location of the erased scene. Chapter mark added by erasing scene cannot be erased.



Erasing an original title

VR mode

You can erase an original title. Erasing the title deletes both the title and the recording saved under that title name. Since the erased title cannot be restored, please make sure that it contains nothing you want to keep. When you erase the title, you can increase the disc space.

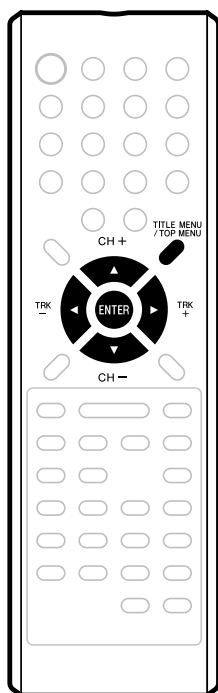

1 Press TITLE MENU to display the title menu.

2 Select the original title you want to erase.

- Press ▲ or ▼ to select the original title.
- Press ► to display the editing menu of original title.
- Press ▲ or ▼ to select "DELETE TITLE".



3 By pressing ENTER, the following message screen will appear.

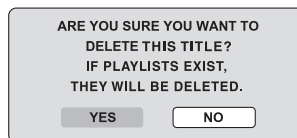

4 Press ◀ or ▶ to select "YES" and press ENTER, then the original title will be erased.

- Erasing the title will be cancelled by selecting "NO".

Note

- If the original title is erased the created playlist is also erased.



Changing a disc name

VR mode **Video mode** **DVD-R**

You can change a disc name from the title menu.

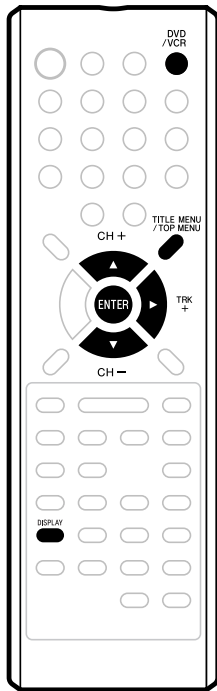

Changing a disc name

- 1 Press **TITLE MENU** to display the title menu.
- 2
 - Press **▲** or **▼** to select "DISC NAME".
 - Press **▶** to display the editing menu.
 - Press **▲** or **▼** to select "RENAME DISC".

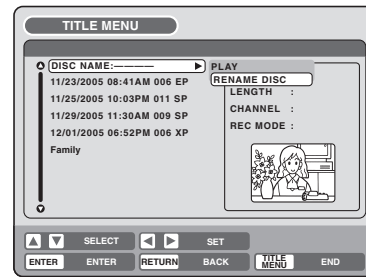

- 3 Press **ENTER**.
The keyboard screen will appear.
- 4 Use the keyboard screen to enter the disc name.

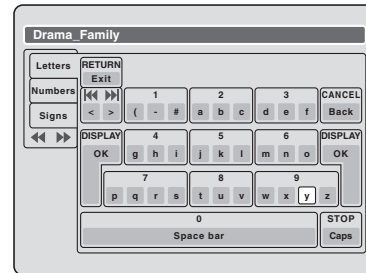

Preparation:

- Turn ON the TV and set to the video input mode.
- Load the recorded DVD disc.
- Press **DVD/VCR** to select the DVD mode. (The DVD indicator will light.)

- 5 Press **DISPLAY** to return to the title menu.

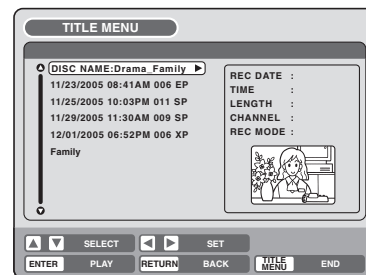

Note

- The disc name can be a maximum of 30 characters. Long names will be shortened in the title menu.
- For using the keyboard screen, see "Using the keyboard screen" (page 76).
- A DVD-R disc cannot be named after it is finalized.





Using the keyboard screen

VR mode **Video mode** **DVD-R**

This section explains the function of the keyboard screen and how to input characters. The disc name and the title name can be changed using the keyboard screen.

Keyboard screen types

The keyboard screen has three types of "Letters", "Numbers" and "Signs". The type can be switched over by pressing **REW** or **F.FWD**.

Letters:

This is mainly used for inputting alphabetical letters. For the keyboard screen of Letters, see the previous page.

Numbers:

This is used for inputting numbers.

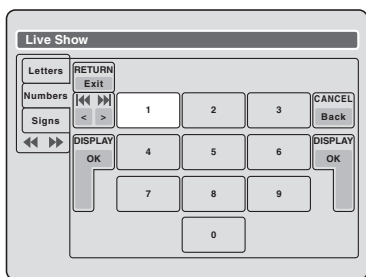

Signs:

This is used for inputting symbols.

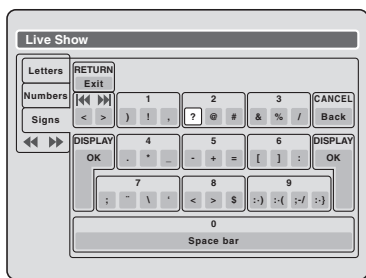

Inputting characters

There are two methods for inputting characters.

Character input 1

1 Press ▲, ▼, ◀ or ▶ to select the character to be input.

2 Press ENTER.

The selected character will be input.

Character input 2

Example: Explained here is the procedure when you input "F" and "J".

1 Press the numeric keys continuously and select the character to be input.

To input F, press 3 three times.



Note

- When the interval between the pressing **numeric keys** is 2 seconds or more in selecting the input character, the selected character will automatically be input.

2 Stop the key operation when you select the character to be input.

The selected character will automatically be input.



3 Press the numeric keys where the following character is assigned.



4 When the character to be input is selected, stop the key operation.

The selected character is automatically input.





Erasing a character

You can erase the input character.

Erasing method 1

1 Press ▲, ▼, ◀ or ▶ to select "Back".

2 Press ENTER.

The last input character will be erased.

3 To erase the characters continuously, press ENTER.

The input characters will be erased from the last to the top one by one.

Erasing method 2

1 Press CANCEL.

The last input character is erased.

2 To erase the characters continuously, press CANCEL.

The input characters will be erased from the last to the top one by one.

Erasing method 3

Use the cursor to select the character and erase it.

1 Press SKIP – or SKIP + to move the cursor after the character you want to erase.

2 Press CANCEL.

Erase the character before the cursor position.

Selecting between uppercase and lowercase letters

You can select either uppercase or lowercase letters when modifying your titles, using the keyboard screen with the "Letters" tab.

1 Press STOP.

(Or, press ▲, ▼, ◀ or ▶ to select "Caps", then press ENTER.)

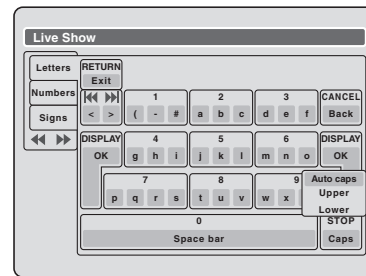

2 Press ▲ or ▼ to select the type of letters in the list below and press ENTER.

Auto caps:

Determines uppercase and lowercase automatically.

Upper:

Inputs all with uppercase letters.

Lower:

Inputs all with lowercase letters.

Determining a name

To determine the entered disc name and title name, press **DISPLAY**. Or, press ▲, ▼, ◀ or ▶ to select "OK", then press **ENTER**.

The keyboard screen disappears and the display will return to the title menu.

The entered disc name and title name are displayed in the title menu.

Cancelling character input

When you want to cancel the input and changed characters, press **RETURN**. Or, press ▲, ▼, ◀ or ▶ to select "Exit", then press **ENTER**.

The input and changed characters are cancelled and the title menu will appear.



Chapter 8 Dubbing

Dubbing a tape onto a disc

VR mode **Video mode** **DVD-R** **VCR**

You can record video or audio on a video tape onto a disc.

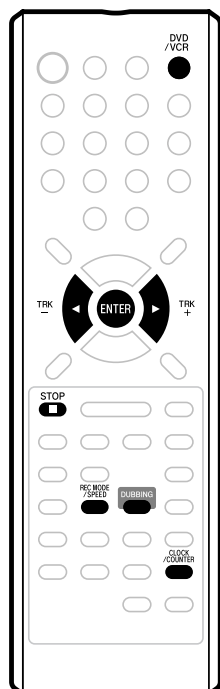

Preparation:

- Turn ON the TV and set to the video input mode.
- Load a source video tape and a disc for recording.
- Remove the erase-protection tab of the source video tape to prevent the data from accidentally being erased.
- Confirm the disc space before operation.

1 Press DVD/VCR to set this unit to DVD mode.

The DVD indicator will light.

2 Press REC MODE/SPEED and select the recording mode.

- When **REC MODE/SPEED** is pressed each time, "SP", "LP", "EP" or "XP" is selected in this order.
- The recording mode is indicated on both the TV screen and the display window.
- For the details of the recording mode, see page 52.

3 Press DVD/VCR and set the unit to VCR mode.

Confirm that the VCR indicator lights.



4 Press DUBBING.

- The unit is changed to DVD mode automatically.
- The VCR is waiting for playback and the DVD is waiting for recording. Then the following message will appear.

5 Press DUBBING, or press ◀ or ▶ to select "YES" and press ENTER.

Dubbing starts.

- To cancel dubbing, press **STOP**, or select "NO" and press **ENTER**.

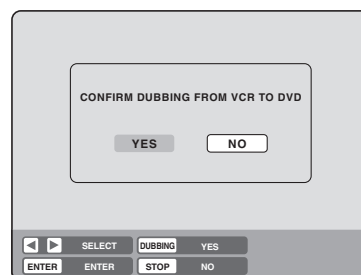

During dubbing, VCR playback, DVD recording and "dub" (dubbing) indicator appear on the display window.

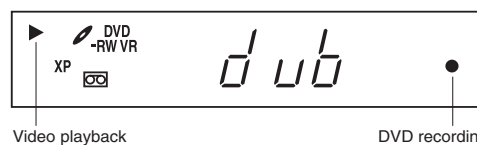

Press **CLOCK/COUNTER** to display the elapsed dubbing time in the display window.

6 To stop dubbing, press STOP.

Note

- Dubbing cannot be accomplished when
 - a copy protected tape is used.
 - disc protection is set.
 - a disc has no recording space.
- Dubbing stops when
 - the video tape is played back to the end and stops.
 - recording space becomes full.
- The videos recorded from TV programs or movies can be used only for your personal enjoyment without permission of the copyright holder.



Dubbing a disc onto a tape

VR mode **Video mode** **DVD-R** **VCR**

You can record both video and audio from a disc to a video tape. When a disc with a copy guard is used, a distorted image is recorded onto the video tape.

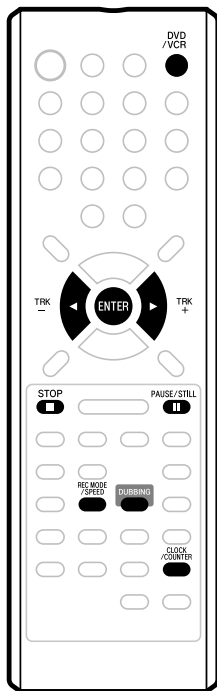

1 Press DVD/VCR to set this unit to VCR mode.

The VCR indicator will light.

2 Press REC MODE/SPEED and select the recording mode.

- When **REC MODE/SPEED** is pressed each time, "SP" or "EP" is selected.
- The recording mode is indicated on both the TV screen and the display window.
- For the details of the recording mode, see page 48.

3 Press DVD/VCR and set the unit to DVD mode.

Confirm that the DVD indicator lights.



4 Press DUBBING.

The DVD is waiting for playback and the VCR is waiting for recording. Then the following message appears.

5 Press DUBBING, or press ◀ or ▶ to select "YES" and press ENTER.

Dubbing starts.

- To cancel dubbing, press **STOP**, or select "NO" and press **ENTER**.

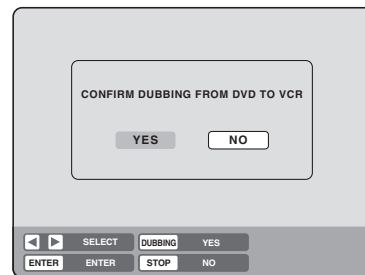

Note

- When a title is played by selecting it from the title menu, only the title selected is played.
- Dubbing cannot be accomplished when
 - a copy protected disc is used.
 - the erase prevention tab of video tape is removed.
- Dubbing stops when
 - the disc is played back to the end and stops.
 - no recording space on the Video tape remains.
 - a length of about 10 seconds goes unrecorded.
- During dubbing, the unit is changed to interlaced scan mode automatically, if it has been previously set to progressive scan mode.
- If no special permission is obtained from the copyright owner, videos recorded from TV programs or movies can only be used for your own personal enjoyment.
- Please forward the first few seconds when you record at the beginning of tape.

Preparation:

- Turn ON the TV and set to the video input mode.
- Load a source disc and a video tape for recording.
- Confirm the remaining tape for recording before operation.

In dubbing, DVD playback, VCR recording and "dub" (dubbing) indicator appear on the display window.

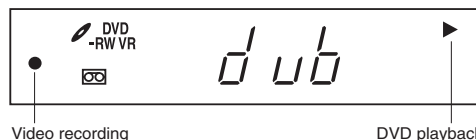

Press **CLOCK/COUNTER** to display the tape counter in the display window.

6 To stop dubbing, press STOP.

Dubbing only the specified titles or the playlist

When you want to dub only specific titles or playlists recorded on the disc, start the playback of the desired title or playlist, and then press **DUBBING** and proceed from step 5 above. Dubbing start from the beginning of the title or playlist.

Dubbing only a specified scene

When you want to dub only specific scene on the disc, press **PAUSE/STILL** at the desired scene, and then press **DUBBING** and proceed from step 5 above.



Dubbing using other equipment

VR mode **Video mode** **DVD-R** **VCR**

You can connect another VCR or camcorder for dubbing.

Preparation:

- Typical connection: When using this unit as a recording device

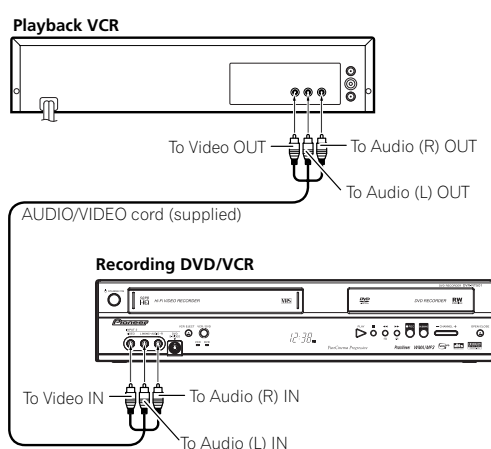

You can also connect to the audio/video input jack (L1) at the rear side of this unit. In addition, each S-Video input jack at the front and rear sides can be used for recording on the disc. (The S-Video input jack cannot be used for recording on the video tape.)

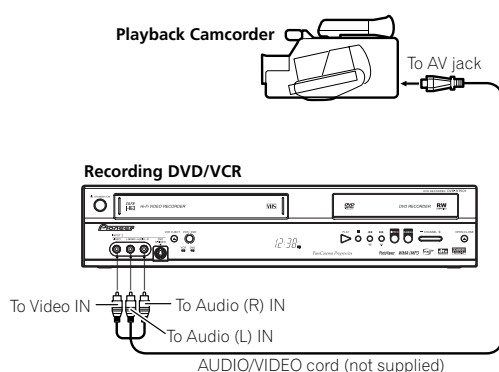

When a video is recorded using this unit

Preparation:

- Turn ON the TV and set the unit to the video input mode.
- Select the input mode in LINE1 (LINE2) INPUT setting on page 30.
- Select the audio mode for the audio input jack in EXTERNAL AUDIO INPUT setting on page 31.
- Load a video tape where the erase-protection tab is not activated or a disc with enough recording space.
- To record onto a video tape, set the unit to VCR mode, whereas to record onto a disc, set it to DVD mode.

1 Press INPUT SELECT and set the channel to L2 (or L1).

L1 (LINE 1): on the rear panel

L2 (LINE 2): on the front panel

Confirm that L2 (or L1) appears on the display window.

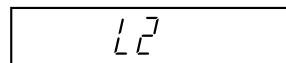

2 Press REC MODE/SPEED and select the recording mode.

VCR: SP or EP (See page 48)

DVD: SP, LP, EP or XP (See page 52)

3 Press REC on this unit and PLAY button on the playback device simultaneously to begin the duplicating process.

4 To stop dubbing, press STOP.

Note

- When this unit is used as a playback device, a mark or a character displayed on the screen is also dubbed as an image. When the screen display is set to OFF, see "DISPLAY" on page 29.
- If no special permission is obtained from the copyright owner, videos recorded from TV programs or movies can only be used for your own personal enjoyment.
- You may not dub a copy protected video or DVD disc.



Chapter 9

Additional information







Language code list





Enter the appropriate code number for the initial settings "DVD MENU", "AUDIO" and/or "SUBTITLE" (see page 24).

Language(Language code letter), **Language Code**

Abkhazian, 1112	Danish, 1411	Italian, 1930	Norwegian, 2425	Swedish, 2932
Afar, 1111	Dutch, 2422	Japanese, 2011	Oriya, 2528	Tagalog, 3022
Afrikaans, 1116	English, 1524	Javanese, 2033	Panjabi, 2611	Tajik, 3017
Albanian, 2927	Esperanto, 1525	Kannada, 2124	Pashto, Pushto, 2629	Tamil, 3011
Amharic, 1123	Estonian, 1530	Kashmiri, 2129	Persian, 1611	Tatar, 3030
Arabic, 1128	Faroese, 1625	Kazakh, 2121	Polish, 2622	Telugu, 3015
Armenian, 1835	Fiji, 1620	Kirghiz, 2135	Portuguese, 2630	Thai, 3018
Assamese, 1129	Finnish, 1619	Korean, 2125	Quechua, 2731	Tibetan, 1225
Aymara, 1135	French, 1628	Kurdish, 2131	Rhaeto-Romance, 2823	Tigrinya, 3019
Azerbaijani, 1136	Frisian, 1635	Laothian, 2225	Romanian, 2825	Tonga, 3025
Bashkir, 1211	Galician, 1722	Latin, 2211	Russian, 2831	Turkish, 3028
Basque, 1531	Georgian, 2111	Latvian, Lettish, 2232	Samoan, 2923	Turkmen, 3021
Bengali; Bangla, 1224	German, 1415	Lingala, 2224	Sanskrit, 2911	Twi, 3033
Bhutani, 1436	Greek, 1522	Lithuanian, 2230	Scots Gaelic, 1714	Ukrainian, 3121
Bihari, 1218	Greenlandic, 2122	Macedonian, 2321	Serbian, 2928	Urdu, 3128
Breton, 1228	Guarani, 1724	Malagasy, 2317	Serbo-Croatian, 2918	Uzbek, 3136
Bulgarian, 1217	Gujarati, 1731	Malay, 2329	Shona, 2924	Vietnamese, 3219
Burmese, 2335	Hausa, 1811	Malayalam, 2322	Sindhi, 2914	Volapük, 3225
Byelorussian, 1215	Hebrew, 1933	Maltese, 2330	Singhalese, 2919	Welsh, 1335
Cambodian, 2123	Hindi, 1819	Maori, 2319	Slovak, 2921	Wolof, 3325
Catalan, 1311	Hungarian, 1831	Marathi, 2328	Slovenian, 2922	Xhosa, 3418
Chinese, 3618	Icelandic, 1929	Moldavian, 2325	Somali, 2925	Yiddish, 2019
Corsican, 1325	Indonesian, 1924	Mongolian, 2324	Spanish, 1529	Yoruba, 3525
Croatian, 1828	Interlingua, 1911	Nauru, 2411	Sundanese, 2931	Zulu, 3631
Czech, 1329	Irish, 1711	Nepali, 2415	Swahili, 2933	

Screen sizes and disc formats

When viewing on a standard TV or monitor		
Screen format of disc	Setting	Appearance
16:9 	4:3 (Letter Box)	The program is shown in widescreen with black bars at the top and bottom of the screen. 
	4:3 (Pan & Scan)	The sides of the program are cropped so that the picture fills the whole screen. Please note that many widescreen discs override the player's settings so that the disc is shown in letter box format regardless of the setting. 
4:3 	16:9	The program appears squashed. Set to either 4:3 (Letter Box) or 4:3 (Pan & Scan). 
	4:3 (Pan & Scan)	The program is presented correctly on either setting. 

When viewing on a widescreen TV or monitor		
Screen format of disc	Setting	Appearance
16:9 	16:9	The program is presented in widescreen. 
4:3 	16:9	Your TV will determine how the picture is presented-check the manual that came with the TV for details.  

Note

- Using the 16:9 (Wide) setting with a standard 4:3 TV, or either of the 4:3 settings with a widescreen TV, will result in a distorted picture.



Glossary

A-B Repeat Playback

Playback that repeats between two set points, A and B.

angle

Recorded onto some DVD discs are scenes which have been simultaneously shot from a number of different angles (the same scene is shot from the front, from the left side, from the right side, etc.). With such discs you can select the angle to view the scene from different angles.

auto chapter

Feature that automatically makes chapter marks on a DVD disc during recording.

auto clock

Feature that automatically sets the internal clock.

blue background

Feature that automatically changes unpleasant noise images to a blue screen when a channel without a broadcast or a channel on which the broadcast has ended has been selected.

BROWSER screen

Screen that appears when TITLE MENU is pressed during MP3, WMA or JPEG CD is inserted.

CABLE

Cable television.

chapter

A section within a title is called a "chapter".

CM Skip

When pressed during playback, playback jumps 30 sec. ahead and resumes.

copy guard

Copyright protection signal. Software and broadcasts that contain this signal cannot be recorded.

Dolby Digital



Dolby® Digital Recording enables consumers to record high-quality video with stereo sound on recordable DVD discs. The technology, when utilized instead of PCM recording, also saves recordable disc space, allowing for higher video resolution or extended recording time on

each DVD. DVDs created using Dolby Digital Recording will play back on all DVD-Video players.

Manufactured under licence from Dolby Laboratories.

"Dolby" and the double-D symbol are trademarks of Dolby Laboratories.

DTS



DTS stands for Digital Theater System. DTS is a surround system different from Dolby Digital that has become a popular surround sound format for movies. *"DTS" and "DTS Digital Out" are registered trademarks of Digital Theater Systems, Inc.*

DVD menu

Menu recorded on a DVD-Video that enables the user to select subtitles language, dubbing, etc.

finalize

Operation that enables discs recorded or edited with this unit to be played back on other DVD players.

interlaced scanning

Technology that alternately displays odd-numbered scanning lines and even-numbered scanning lines. Also called "480i", "i" meaning "interlace".

letter box

Feature that displays black bands above and below the playback images during playback of a disc recorded in wide (16:9) format on a 4:3 TV connected to this unit.

MP3

One type of audio compression that uses MPEG1. This format compresses the sound to use up about 1/10 of the original file space, with minimal loss of sound quality.

one touch repeat

If ONE TOUCH REPEAT is pressed during playback, playback returns to a point 10 sec earlier and resumes.

original title

The file created by recording something is called an "original title".

OTR

One-touch Timer Recording. Start a timed recording by pushing just one button (up to 6 hours).

pan scan

Feature that cuts the left and right edges of playback images to a 4:3 size during playback of a disc recorded



in wide (16:9) format on a 4:3 TV connected to this unit.

parental control

Some discs control viewing according to the age of the viewer. A control level can be set for those types of discs.

PBS

Acronym for Public Broadcast System. The PBS channel transmits data for auto clock setting.

playlist

User-created titles based on each original title.

Progressive scan

Technology that simultaneously displays odd-numbered scanning lines and even-numbered scanning lines from top to bottom. Also called "480p", "p" meaning "progressive".

Regions (DVD only)



(example region code marks)

Regions associate discs and players with particular areas of the world. This unit will only play discs that have compatible region codes. You can find the region code of your unit by looking on the rear panel. Some discs are compatible with more than one region (or all regions).

SETUP MENU

Menu that contains settings for various features of this unit, such as recording and playback. Timer recording is also set from the SETUP MENU.

slide show

Technique for flipping through and viewing many images (JPEG files).

subtitle language

Language used for subtitles of movies, etc. Viewers can watch in a language of their choosing.

title

A program recorded on a disc is called a "title".

title menu

Menu that lists titles and tracks recorded on the disc. It is used for playback and disc editing.

top menu

Menu on a DVD-Video for selecting chapters for

playback, subtitle language, etc. Some DVD-Video call this top menu "Title".

track

A song on a music CD is called a "track".

TRACK INFO screen

The screen that appears when TITLE MENU is pressed, if a music CD disc is in the unit.

Video mode

This recording format is compatible with commercially available DVD players.

VR mode

This recording format is the basic DVD-RW recording format, and lets you enjoy the various editing functions available with this unit.



Error/Warning message list

	ERROR/WARNING MESSAGE	CAUSE	POSSIBLE SOLUTIONS	PAGE
Power ON	SYSTEM ERROR PLEASE WAIT	The power was shut down without completing the termination process due to a power failure or disconnection of the AC cord plug. (Abnormal termination)	Wait until the message disappears.	--
	SYSTEM ERROR PLEASE WAIT DISC CHECKING	The power was abruptly turned off before writing to the disc was completed.	The data is now restoring.	--
	SYSTEM ERROR DISC MIGHT BE FAILED PRESS ENTER	The data restoration was completed.	Press ENTER , then the screen returns to the normal display. The data may not be restored even if the restoration process is performed.	52
Playback	NO DISC	When a disc was not loaded in the unit, PLAY was pressed.	Load a disc.	33
	REGION CODE ERROR	A disc specified other than "Region 1" or "Region ALL" was loaded.	A disc specified other than "Region 1" or "Region ALL" cannot be played back.	9, 83
	INCORRECT DISC - C104, C105, C106, C107	The disc cannot be identified.	Check the disc and load a proper disc.	9
	PROGRESSIVE OUTPUT. STOP DISC PLAY BACK THEN PRESS PROGRESSIVE TO CANCEL.	When the unit was not connected to the TV with the component video cables, PROGRESSIVE was pressed.	Press PROGRESSIVE in the stop mode to make the progressive scanning mode inactive.	47
Recording	NO DISC	When a disc was not loaded into the unit, REC was pressed.	Load a disc.	54
	PROCESSING PLEASE WAIT	The recording termination is processing.	Wait until the process is completed.	--
	RECORDING INTERRUPTED - C204	Disc became full during recording.	Erase unnecessary titles or load another disc and restart recording.	74
	CANNOT RECORD - C203	Recording was tried onto the disc having no space.	Check the disc space.	35
	CANNOT RECORD - C206	Recording was tried onto the disc which does not support recording.	Load a recordable disc.	9
	CANNOT RECORD - C207	Disc erase-protection is applied.	Set "Protect disc" to "OFF".	28
	CANNOT RECORD - C208	Recording was tried onto the finalized disc.	Undo finalization or load another disc for recording.	28
	CANNOT RECORD - C209	Adding data was tried onto the disc recorded in the other unit.	Load another disc for recording.	--
	CANNOT RECORD - C210	Adding data was tried to the disc where PC data was recorded.	Load another disc for recording.	--
	DISC ERROR - C205, C211, C212, C213	A scratch or contamination was found on the disc.	Check the disc and reload it, or use another disc for recording.	--
	CANNOT RECORD, EXCEEDS LIMITED NUMBER OF TITLES	99 titles were recorded on the disc.	Erase unnecessary titles or load another disc.	74
CANNOT RECORD, EXCEEDS LIMITED NUMBER OF CHAPTERS	999 chapters exist on the disc.	Erase unnecessary chapters or load another disc.	72	



Additional information

09

	ERROR/WARNING MESSAGE	CAUSE	POSSIBLE SOLUTIONS	PAGE
	CANNOT RECORD PROTECTED IMAGE	You tried to record a copy-guard video.	You cannot record to the video containing copy-guard signal.	53
	RECORDING INTERRUPTED PROTECTED IMAGE	The video was changed to a copy-guard format in recording.	You cannot record to the video containing copy-guard signal.	53
	CANNOT RECORD IN VIDEO MODE. COPY IMAGE ONCE ONLY.	Recording was attempted of a "Copy Once" program onto a disc (Video mode).	Load a DVD-RW Ver. 1.1/1.2(VR mode) with CPRM.	53
	CANNOT RECORD ON DISC. THIS IS NOT CPRM DISC.	Recording was attempted of a "Copy Once" program onto a disc without CPRM.	Load a DVD-RW Ver. 1.1/1.2(VR mode) with CPRM.	53
	TIMER RECORDING ERROR PLEASE CHECK THE DISC OR TAPE	When a recordable tape is not inserted or no disc space is available, TIMER REC was pressed	Load a recordable tape or disc.	59,61
Dubbing	SWITCHING TO INTERLACE OUTPUT FOR COPYING	Dubbing was initiated from a disc to a video tape in the progressive scan mode.	The mode is automatically changed to interlaced mode if dubbing from a disc to a video tape.	79
	CANNOT COPY DATA - C251	No video tape or disc is inserted as a source for the recording.	Load a video tape or disc into the source drive.	78, 79
	CANNOT COPY DATA - C254, C255	The source video or disc to be copied is copy-guarded.	You cannot dub a video containing copy-guarded material.	53
	COPYING INTERRUPTED	The video tape or disc became full during dubbing.	Load another video tape or disc for recording and restart.	78, 79
Disc setup	DISC ERROR - C302, C303	Cannot Format disc due to a scratch or contamination on the disc.	Check the disc and reload it, or use another disc for recording.	--
	DISC ERROR - C304, C305	Cannot Finalize disc due to a scratch or contamination on the disc.	Check the disc and reload it, or use another disc for recording.	--
	DISC ERROR - C306	Cannot Undo Finalize disc due to a scratch or contamination on the disc.	Check the disc and reload it, or use another disc for recording.	--
	DISC ERROR - C307, C308	Cannot Protect disc ON/OFF due to a scratch or contamination on the disc.	Check the disc and reload it, or use another disc for recording.	--
Title Menu	CANNOT EDIT	Editing cannot be performed due to a scratch or contamination on the disc.	Check the disc and reload it, or use another disc for recording.	--
	CANNOT EDIT - C408	Combining chapters cannot be performed.	Chapter marks that have been added automatically in the erasing of a scene procedure cannot be erased.	72
	PROCESSING PLEASE WAIT	A process requiring a longer time such as editing is being performed.	Wait until the process is complete.	--



Note

- Any error/warning message other than those above might appear. Take measures against such a message by seeing the possible solutions above.

85

En



Troubleshooting

Incorrect operation is often mistaken for trouble and malfunction. If you think there is something wrong with this component, please check the points below. Sometimes the trouble may lie in another component. Investigate the other components and electrical appliances being used. If the trouble cannot be rectified even after checking the points below, ask your nearest Pioneer authorized service center or your dealer to carry out repair work.



Note

- If the unit does not operate normally due to external effects such as static electricity, disconnect the power plug from the AC outlet and insert again to return to normal operating conditions.
If the unit will not work even if the power cord is unplugged and plugged back in, unplug the cord from the AC outlet for about 4 hours and then try plugging it back in and turn on the power.

DVD/VCR

SYMPTOMS	POSSIBLE SOLUTIONS	PAGE
DVD/VCR does not operate.	• Make sure the power cord is plugged in.	15
	• Try another AC outlet.	--
	• Power is off, check fuse or circuit breaker.	--
	• Unplug unit, then plug it back in.	15
	• Select the DVD or VCR mode before operating.	33, 49
No picture.	• Antenna connection is not correct or antenna cable is disconnected.	16~19
	• The video channel is not in the correct position or the TV is not set to the video channel 3 or 4.	22
	• Check the unit is connected correctly.	16~21
	• The video input selector of the TV is not set to VIDEO. Set to VIDEO (or equivalent).	--
	• Channel is set to the external mode.	--
No sound.	• Check the unit is connected correctly.	16~21
	• Check the input selector of the amplifier is set properly.	--
	• The unit is in the Special playback mode.	36, 50
The remote control does not function.	• Aim at the remote control at the remote sensor.	15
	• Operate within Approx. 5 meters or reduce the light in the room.	
	• Clear the path of the beam.	
	• The batteries are weak. Replace the batteries.	
	• Check the batteries are inserted correctly.	
No Cable TV reception	• Check all Cable TV connections.	18, 19
	• Station or Cable TV system problems, try another station.	
No function in DVD mode	<ul style="list-style-type: none"> This unit may on rare occasions stop working in certain situations, such as when a soiled or damaged disc is used. If this occurs, hold down STANDBY/ON on the unit for 10 seconds or longer to reset the unit. The unit may also automatically reset itself if it detects a problem. If the unit performs a reset of this sort while data is being recorded onto a disc, it may in rare cases no longer be possible to successfully record to or play back from the disc. 	--

DVD

SYMPTOMS	POSSIBLE SOLUTIONS	PAGE
Display is not shown in your language.	• Select proper language in the SETUP MENU.	24
Playback doesn't start.	• No disc is inserted.	33
	• The disc may be dirty. Clean up the disc.	88
	• Check that the disc is not a DVD-RAM, DVD+R/RW, dual disc (DVD/CD hybrid disc) or other incompatible format disc.	9
Stopping playback, search, slow-motion play, repeat play, or program play, etc. cannot be performed.	• Some discs may not do some of the functions.	--
Recording does not work.	• Check the disc space, using the disc information.	35
	• Check the disc for protection.	28
	• Check if the video to be recorded is not "copy-guarded".	53
	• Check that the number of recorded titles is 99 or less, using the disc information.	35, 52
	• Check the number of the total chapters for the recorded titles is 999, using the disc information.	35, 70
	• In a DVD-RW of Ver.1.0, recording in Video mode does not work. Check the disc type.	10



Additional information

09

SYMPTOMS	POSSIBLE SOLUTIONS	PAGE
A disc recorded using this recorder cannot be played back in other players.	• Check that the disc is finalized.	28
	• Some DVD players will not play even if the disc has been finalized.	10, 28
	• If the disc was recorded in VR mode, the other player must be RW compatible in order to play the disc.	10, 28

VCR

SYMPTOMS	POSSIBLE SOLUTIONS	PAGE
TV recording does not work.	<ul style="list-style-type: none"> • The erase prevention tab of the video cassette is broken off. • The unit is in the external input mode. 	48, 54
Timer recording does not work.	• The time is not set correctly.	26
	• The recording start/end time is not set correctly.	60
	• TIMER REC has not been pressed (is not lit).	61
Noise bars on screen.	• Tracking adjustment beyond range of automatic tracking circuit. Try Manual tracking adjustment.	50
	• Video heads are dirty.	89
	• The tape is worn or damaged.	--

OTHER

SYMPTOMS	POSSIBLE SOLUTIONS	PAGE
No picture, or screen is blurred or divided into two parts.	• The progressive scan mode is active through the unit is connected to a TV via the VIDEO OUT jack.	47
No 4:3 (16:9) picture	• The setup does not match your TV.	29
No on-screen display	• Select Display "ON".	29
Nothing appears in the display window	• Check the DIMMER setting for SETUP.	29
No surround sound	• The setup does not match your stereo system.	21
The unit or remote operation key is not functioning.	• Turn off the unit and unplug the AC power cord for several minutes, then replug it.	--
Playback does not start when the title is selected.	• Check the Parental setup.	25
Audio soundtrack and/or subtitle language is not changed when you playback a DVD.	• Multilingual language is not recorded on the DVD disc.	24
No subtitles	<ul style="list-style-type: none"> • Some discs have no subtitles. • Subtitles are cleared. Press SUBTITLE. 	24, 41
Angle cannot be changed.	• Multi-angles are not recorded on the DVD disc.	--
"⊞" appears on the screen.	• The function is prohibited with the unit or the disc.	--

87

En



Handling discs

When holding discs of any type, take care not to leave fingerprints, dirt or scratches on the disc surface. Hold the disc by its edge or by the center hole and edge. Damaged or dirty discs can affect playback and recording performance. Take care also not to scratch the label side of the disc. Although not as fragile as the recorded side, scratches can still result in a disc becoming unusable. Should a disc become marked with fingerprints, dust, etc., clean using a soft, dry cloth, wiping the disc lightly from the center to the outside edge as shown in the diagram below.



If necessary, use a cloth soaked in alcohol, or a commercially available CD/DVD cleaning kit to clean a disc more thoroughly. Never use benzine, thinner or other cleaning agents, including products designed for cleaning vinyl records.

Storing discs

Although CDs and DVD discs are more durable than vinyl records, you should still take care to handle and store discs correctly. When you're not using a disc, return it to its case and store upright. Avoid leaving discs in excessively cold, humid, or hot environments (including under direct sunlight). Don't glue paper or put stickers onto the disc, or use a pencil, ball-point pen or other sharp-tipped writing instrument. These could all damage the disc.



For more detailed care information see the instructions that come with discs.
Do not load more than one disc into the recorder.

Damaged discs

Discs spin at high speed inside the recorder. If you can see that a disc is cracked, chipped, warped, or otherwise damaged, don't risk using it; you could end up damaging the recorder.

This recorder is designed for use with conventional, fully circular discs only. Use of shaped discs is not recommended for this product. Pioneer disclaims all liability arising in connection with the use of shaped discs.

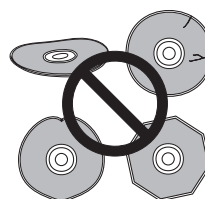

Cleaning the pickup lens

The DVD recorder's lens should not become dirty in normal use, but if for some reason it should malfunction due to dust or dirt, consult your nearest Pioneer-authorized service center. Although lens cleaners for CD players are commercially available, we do not recommend using them since some may damage the lens.

Handling video tapes

Please do not use the following kinds of video tape:

- Dusty or mouldy tape
- Tape on which liquid has been spilled
- Tape which has been broken and then repaired
- Tape which has become unwound from the spools in the cassette
- Dirty heads and very long length, thin video tape can cause problems such as uneven playback.
- When using a new video tape, fast-forward to the end, then rewind it back to the start before using.
- Avoid dropping video tapes or exposing them to severe vibration.

Storing video tapes

- After using a video tape, rewind it back to the beginning and return to its case.
- Do not store tapes:
 - in excessively dusty places
 - in excessively hot or humid places
 - in direct sunlight
 - near air-conditioners or heaters
 - near strong magnetic fields



Video head cleaning

Video head clogging

The video heads are the means by which the DVD/VCR reads the picture from the tape during playback. In the unlikely event that the heads become dirty enough to be clogged, no picture will be played back. This can easily be determined if, during playback of a known good tape, there is good sound, but no picture (picture is extremely snowy). If this is the case, have the DVD/VCR checked by qualified service personnel.



Normal



When head is dirty



Note

- DO NOT ATTEMPT TO CLEAN THE VIDEO HEADS OR SERVICE THE UNIT BY REMOVING THE TOP COVER.
- Video heads may eventually wear out and should be replaced when they fail to produce clear pictures.
- To help prevent video head clogging, use only good quality VHS tapes. Discard worn out tapes.
- We do not recommend using wet-type head-cleaning cassettes as they may damage the unit.

Moving the recorder

If you need to move the recorder, first remove the disc and the cassette, if they are loaded, and close the disc tray. Next press **STANDBY/ON** to switch the power to standby. Lastly, disconnect the power cord.

Resetting the recorder

If you need to, you can reset the recorder to all its factory settings.

- 1 Make sure that the recorder is on and remove the disc.**
- 2 Press and hold ■ STOP and press ⏻ STANDBY/ON.**

The recorder turns off with all settings reset.

Hints on installation

We want you to enjoy using this unit for years to come, so please bear in mind the following points when choosing a suitable location for it:

Do...

- ✓ Use in a well-ventilated room.
- ✓ Place on a solid, flat, level surface, such as a table, shelf or stereo rack.

Don't...

- ✗ Use in a place exposed to high temperatures or humidity, including near radiators and other heat-generating appliances.
- ✗ Place on a window sill or other place where the recorder will be exposed to direct sunlight.
- ✗ Use in a dusty or damp environment or in a room where it will be exposed to excessive cigarette smoke.
- ✗ Place directly on top of an amplifier, or other component in your stereo system that becomes hot in use.
- ✗ Use near a television or monitor as you may experience interference-especially if the television uses an indoor antenna.
- ✗ Use in a kitchen or other room where the recorder may be exposed to smoke or steam.
- ✗ Use on a thick rug or carpet, or cover with cloth-this may prevent proper cooling of the unit.
- ✗ Place on an unstable surface, or one that is not large enough to support all four of the unit's feet.



Specifications

GENERAL

Power supply	AC 120V 60Hz
Power consumption	Operation: 27W
	Standby: 2.5W (if display window is off.)
Weight	11.0 lbs (5.0 kg)
Dimensions	Width: 16-15/16 inches (430 mm)
	Height: 3-9/16 inches (90 mm)
	Depth: 12-5/8 inches (320 mm)
Operating temperature	41°F to 95°F (5°C to 35°C)
Operating humidity	Less than 80% RH
Inputs/Outputs:	
Video	In: 1Vp-p/75 ohm
	Out: 1Vp-p/75 ohm
Audio	In: -8dBm/50k ohm
	Out: -8dBm/1k ohm
Antenna	UHF/VHF IN/OUT: 75 ohm coaxial
Program	12 programs/1 month
Power off memory	Approx. 30 min.

VCR section

Video head	4 Rotary Heads
Audio track	Hi-Fi Sound - 2 Tracks
	MONO Sound - 1 Track
Hi-Fi frequency response	20Hz to 20,000Hz
Hi-Fi dynamic range	More than 90dB
Tuner	181 Channel Freq. Synthesized
VHF	2-13
UHF	14-69
CABLE .. 14-36 (A)-(W) 37-59 (AA)-(WW) 60-85 (AAA)-(ZZZ)	
	86-94 (86)-(94) 95-99 (A-5)-(A-1) 100-125 (100)-(125)
	01 (5A)
RF channel output	Channel 3 or 4, Switchable
F.FWD/REW Time	Approx. 1 minute and 48 seconds
	(with T-120 Cassette Tape)(at +25°C)

DVD section

Signal system	NTSC
Applicable disc	DVD (12cm, 8cm), CD (12cm, 8cm)
Recording format	DVD-Video Recording (VR mode)
	DVD-VIDEO (Video mode)
Recording discs	DVD-RW, DVD-R
Recording time (based on a 4.7GB disc)	
XP	Approx. 60 min
SP	Approx. 120 min
LP	Approx. 240 min
EP	Approx. 360 min

Audio characteristics

frequency response	DVD: 4Hz - 22kHz
	CD: 4Hz - 20kHz
S/N Ratio	90dB
Harmonic distortion	Less than 1%
Wow and flutter	Less than 0.01% Wrms
Dynamic range	More than 90dB

Output	Video: (RCA) 1 Vp-p/75 ohm
	Audio : (RCA) -12 dB/1k ohm
	Digital Audio : 0.5Vp-p/75 ohm
Pickup	CD : Wavelength: 780 nm
	Maximum output power: 8.5 mW
	DVD : Wavelength: 660 nm
	Maximum output power: 120 mW

ACCESSORIES

Remote control	1
Dry cell batteries (AAA/R03)	2
Audio / Video cable (red/white/yellow)	1
RF antenna cable	1
Blank DVD-RW disc	1
Warranty card	1
Quick Start Guide	1
Operating Instructions	

Note: The specifications and design of this product are subject to change without notice, due to improvement.





Should this product require service in the U.S.A. and you wish to locate the nearest Pioneer Authorized Independent Service Company, or if you wish to purchase replacement parts, operating instructions, service manuals, or accessories, please call the number shown below.

8 0 0 - 4 2 1 - 1 4 0 4

Please do not ship your product to Pioneer without first calling the Customer Support Division at the above listed number for assistance.

Pioneer Electronics Service Inc.
Customer Support Division
P.O. BOX 1760, Long Beach,
CA 90801-1760, U.S.A.

For warranty information please see the Limited Warranty sheet included with your product.

Should this product require service in Canada, please contact a Pioneer Canadian Authorized Dealer to locate the nearest Pioneer Authorized Service Company in Canada. Alternatively, please contact the Customer Satisfaction Department at the following address:

Pioneer Electronics of Canada, Inc.
Customer Satisfaction Department
300 Allstate Parkway, Markham, Ontario L3R OP2
(905)479-4411
1(877)283-5901

For warranty information please see the Limited Warranty sheet included with your product.

Si ce produit doit être réparé au Canada, veuillez vous adresser à un distributeur autorisé Pioneer du Canada pour obtenir le nom du Centre de Service Autorisé Pioneer le plus près de chez-vous. Vous pouvez aussi contacter le Service à la clientèle de Pioneer:

Pioneer Electroniques du Canada, Inc.
Service à la clientèle
300, Allstate Parkway, Markham, Ontario L3R OP2
(905)479-4411
1(877)283-5901

Pour obtenir des renseignements sur la garantie, veuillez vous reporter au feuillet sur la garantie restreinte qui accompagne le produit.

S018D_enfr

Published by Pioneer Corporation.
Copyright © 2005 Pioneer Corporation.
All rights reserved.

PIONEER CORPORATION

4-1, Meguro 1-Chome, Meguro-ku, Tokyo 153-8654, Japan

PIONEER ELECTRONICS SERVICE INC.

P.O. BOX 1540, Long Beach, California 90810-1540, U.S.A. TEL: (800) 421-1404

PIONEER ELECTRONICS OF CANADA, INC.

300 Allstate Parkway, Markham, Ontario L3R OP2, Canada TEL: (905) 479-4411

PIONEER EUROPE NV

Haven 1087, Keetberglaan 1, B-9120 Melsele, Belgium TEL: 03/570.05.11

PIONEER ELECTRONICS ASIACENTRE PTE. LTD.

253 Alexandra Road, #04-01, Singapore 159936 TEL: 656-472-1111

PIONEER ELECTRONICS AUSTRALIA PTY. LTD.

178-184 Boundary Road, Braeside, Victoria 3195, Australia, TEL: (03) 9586-6300

PIONEER ELECTRONICS DE MEXICO S.A. DE C.V.

Bldv.Manuel Avila Camacho 138 10 piso Col.Lomas de Chapultepec, Mexico,D.F. 11000 TEL: 55-9178-4270

K002E

Printed in Thailand

<VRB1391-B>



J2G00201B SH 05/04

